



BUTTERFLY TABLE TENNIS EQUIPMENT

RUBBER / BLADES / APPAREL / TABLES / ROBOTS / BALLS



2017 TECH CATALOG

TENERGY 05

Excellent for Imparting Spin on the Ball

HIGH TENSION

Spring Sponge

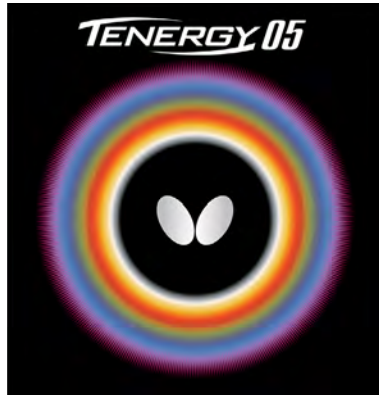

TENERGY 05 FX

Topspin and Control

HIGH TENSION

Spring Sponge



TENERGY 25

Excellent for Attacking and Controlled Play near the Table

HIGH TENSION

Spring Sponge

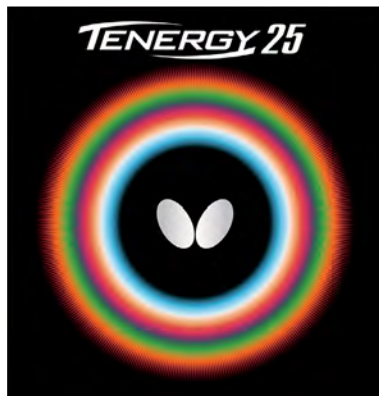

TENERGY 25 FX

For Power and Control

HIGH TENSION

Spring Sponge



TENERGY 64

The Speed Effect

HIGH TENSION

Spring Sponge

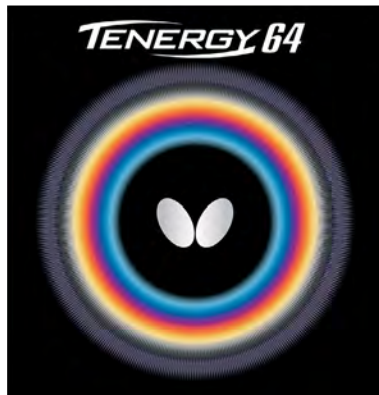

TENERGY 64 FX

For Speed and Control

HIGH TENSION

Spring Sponge



TENERGY 80

Ideal Balance Between Spin and Speed

HIGH TENSION

Spring Sponge

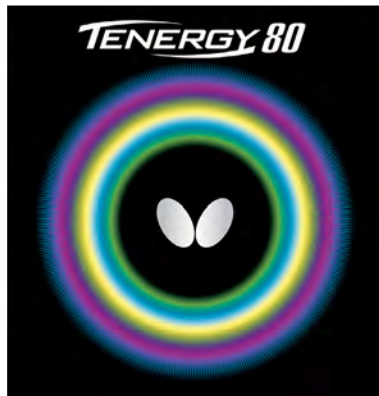

TENERGY 80 FX

Ideal Balance Between Spin and Speed with Control

HIGH TENSION

Spring Sponge



New >>>

BRYCE HIGHSPEED

High-Performance Rubber with Unique Technology "Micro Layer"

MICROLAYER

A NEW ACHIEVEMENT OF THE BUTTERFLY RESEARCH

Microlayer Technology was developed to offer more spin at a high rate of speed. The topsheet is designed thinner than other Butterfly rubbers. This new concept helps the rubber to grip more of the balls' surface, allowing you to impart the most spin at a high degree of speed.

MICROLAYER

HIGH TENSION



BRYCE SPEED

High Tension Rubber Which Goes Beyond Bryce

HIGH TENSION



BRYCE SPEED FX

Bryce Speed with Higher Control

HIGH TENSION



BRYCE

The World's First High Tension Rubber

HIGH TENSION



BRYCE FX

The High Tension Rubber with a Softer Touch

HIGH TENSION



Spring Sponge

THE SENSE OF "CATCHING" BALLS

More than a decade of research has led to the latest sponge technology created by the engineers at Butterfly, Spring Sponge. The most notable feature of this new technology is a sense of "catching" the ball. The secret to the Spring Sponge is the unique material composition and air inside the sponge; it expands and contracts just like a spring! Spring Sponge will make you feel in total control.

SPIN ART

High Friction High Tension Rubber with Strengthened Bounce

HIGH TENSION
Spring Sponge



HIGH TENSION

TOP ATHLETES RELY ON ITS TECHNOLOGY

Incorporating tension in the sponge, the rubber surface or combined in both. High Tension stands for a modern table tennis characterized by lots of feel, spin variations and fierce dynamics.

Intensive research made possible a broad selection of high powered rubbers which comply with the highest quality standards:

- The optimized surface remains adhesive without protective film, like all our rubbers
- If the rubber is exposed to oxygen, it does not cause stains to the surface
- These rubbers are more resistant to blistering and cracks despite their high tension
- The tension is evenly balanced, thus there will not be any deformation of the rubber

ROUNDELL

Fulfill Your Potential

HIGH TENSION

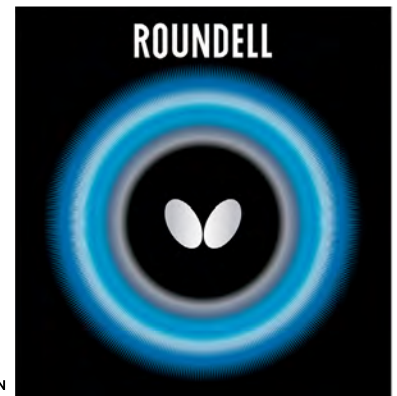

ROUNDELL HARD

Speed, Spin and Control

HIGH TENSION

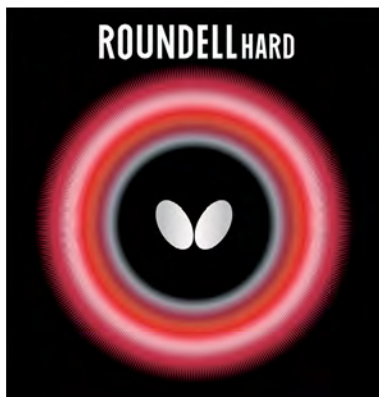
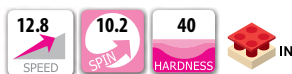

ROUNDELL SOFT

Speed and Spin

HIGH TENSION



SRIVER G3

SRIVER – Generation Three for the Non-Glue Era

HIGH TENSION



SRIVER G3 FX

SRIVER G3 with Greater Control

HIGH TENSION

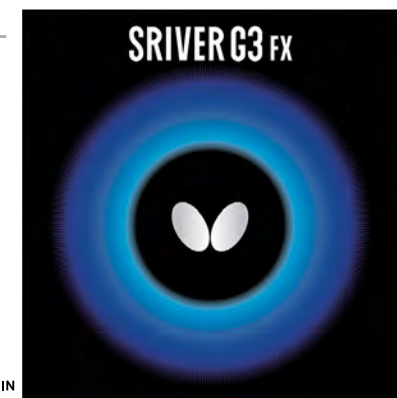

SRIVER

The World's Longtime Best Seller

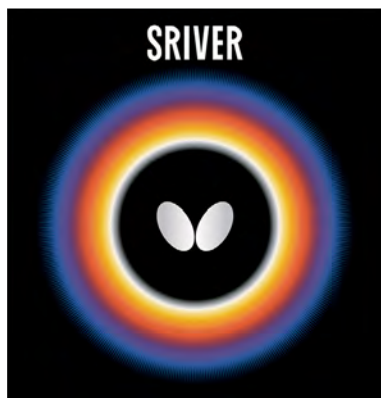

SRIVER EL

SRIVER with Instant Power and Control

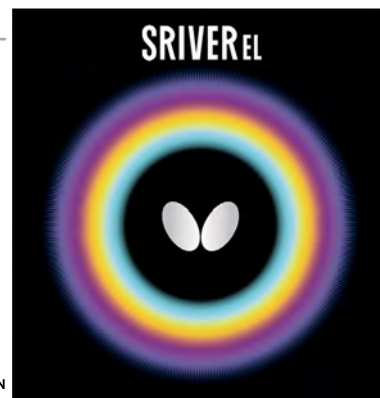

SRIVER FX

SRIVER with Outstanding Stability



FLEXTRA

Easy-to-Handle Rubber for Developing Players

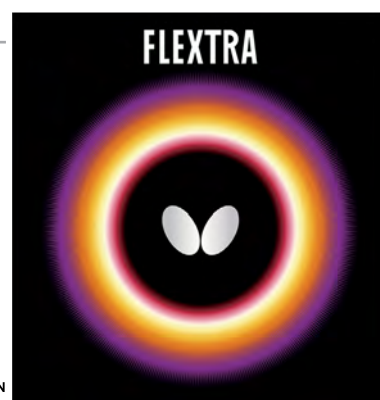

SAPPHIRA

Easy-to-Handle Rubber for Attack

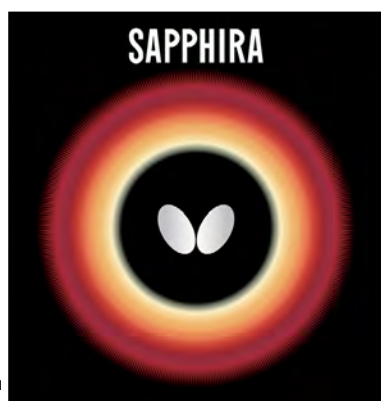

TACKIFIRE DRIVE

Well-Balanced Friction Rubber



TACKIFIRE C

A Lot of Spin by the Highly Tacky Surface



TACKIFIRE C SOFT

High Tackiness Rubber with Usability

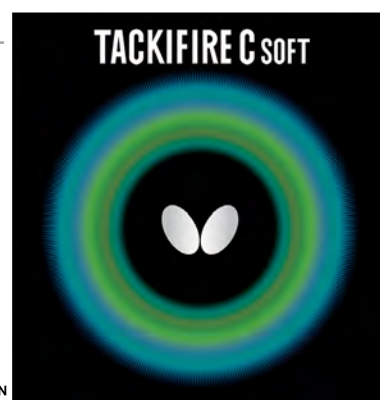

TACKINESS CHOP

Friction Rubber for Defensive Players

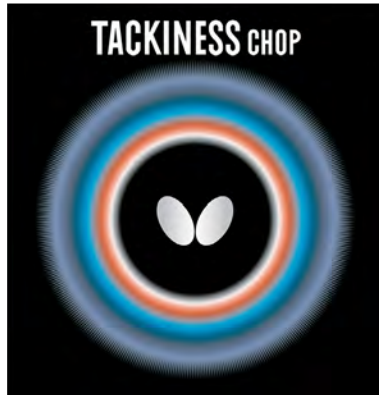

TACKINESS CHOP II

Friction Rubber Good at Spinning

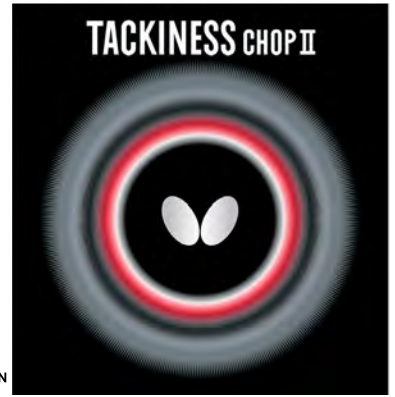

TACKINESS DRIVE

Friction Rubber for Wide Range of Players



SUPER ANTI

Anti Rubber to Toss Opponents

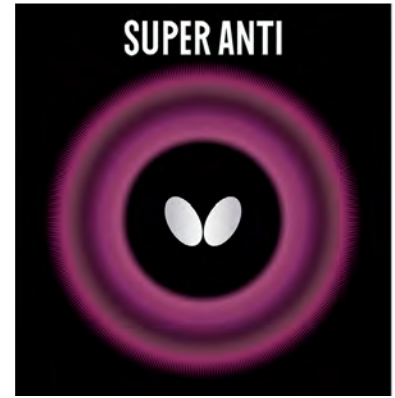

CHALLENGER ATTACK

Pimples-Out Rubber for Quick Attack



SPEEDY P.O.

Well-Balanced Pimples-Out with an Ideal Parabola

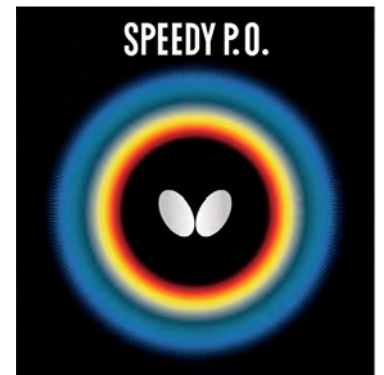

FLARESTORM II

High Tension Pimples-Out with High Reaction



HIGH TENSION



RAYSTORM

High Tension Pimples-Out with High Elasticity and Spin



HIGH TENSION



IMPARTIAL XB

New >>>

Pursuit of Balance of
Offense and Defense

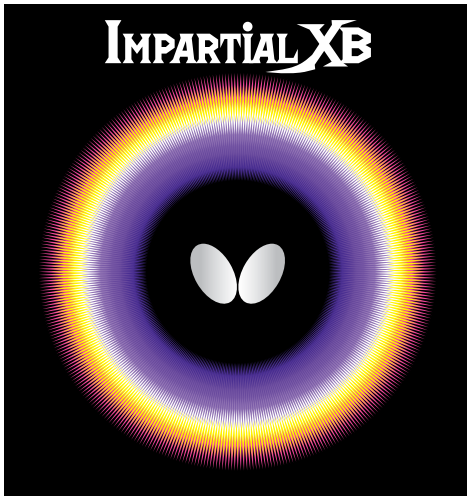

HIGH TENSION



IMPARTIAL XS

New >>>

High Spin, Allows for
Powerful Drives

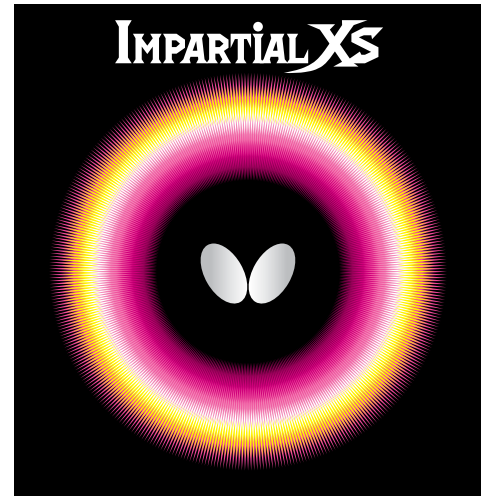

HIGH TENSION



ORTHODOX DX

Pimples-out without
Sponge with Usability

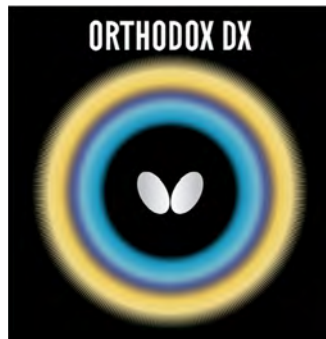

FEINT AG

High Tension Long
Pimped Rubber for
Attacking Players



HIGH TENSION



FEINT LONG II FEINT LONG II OX

Long Pimped Rubber
for Steady Plays



FEINT LONG III

Long Pimped Rubber
with Amazing Variety
of Spins

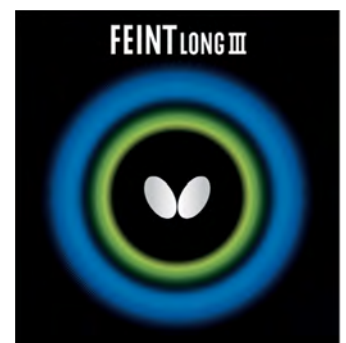

FEINT OX

Well-Balanced Long
Pimped without
Sponge



FEINT SOFT

Well-Balanced Long
Pimped Rubber

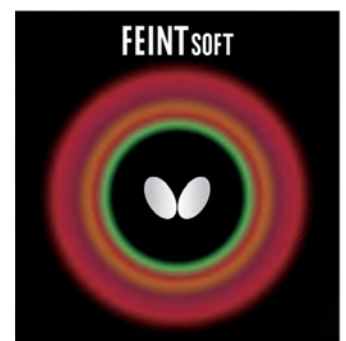

Rubber Matrix



Isotype for Butterfly Rubber

Sponge

MAX THICKNESS	3.8-4.0mm (Including Rubber Sheet)	2.1 THICKNESS	1.9-2.2mm
1.9 THICKNESS	1.7-1.9mm	1.7 THICKNESS	1.5-1.7mm
1.3 THICKNESS	1.1-1.3mm	1.1 THICKNESS	0.8-1.1mm
		0.5 THICKNESS	0.4-0.7mm

Speed

10 SPEED The measure for speed of SRIVER is 10.

Spin

10 SPIN The measure of spin for TACKINESS CHOP is 10.

Hardness

38 HARDNESS It refers to the sponge; the higher the number, the harder the sponge.

• The numbers are based on the research conducted by the Butterfly Research and Development Department in January, 2016.

Rubber Categories

Pimples-in Rubber

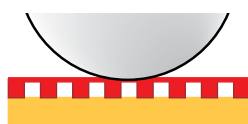

● Pimples-in Rubber

A rubber with a large contact area for the ball, which makes it easy to impart spin; there are two types, highly elastic with high reaction and moderate for control.

● High Tension Pimples-in Rubber

A rubber with very high elasticity and friction; it is created by impacting tension into the rubber molecule.

● High Friction Pimples-in Rubber

A rubber which imparts spin on the ball with ease as a result of the tackiness of the surface.

● High Friction High Tension Pimples-in Rubber

A rubber with very high elasticity and friction created by impacting tension into the rubber molecule as well as enabling spin to be imparted on the ball owing to the tackiness of the surface.

Pimples-out Rubber



● Pimples-out Rubber

A rubber with a small contact area on the ball, which means it is less affected by the opponent's spin as the ball does not stay on the rubber for long.

● High Tension Pimples-out Rubber

A pimples-out rubber with very high elasticity created by impacting tension into the rubber molecule.



● Pimples-out Rubber (without Sponge)

A rubber without sponge; it is light weight and has low elasticity.

Long Pimples Rubber



● Long Pimples Rubber

A long pimples rubber with unexpected variety of rotations as the pimples easily transform on contact.

● High Tension Long Pimples Rubber

A long pimples rubber which combines variation and elasticity; created by impacting tension into the rubber molecule.



● Long Pimples Rubber (without Sponge)

A long pimples rubber without sponge; it is light weight and has low elasticity.

Anti-Spin Rubber



● Anti-Spin Rubber

A rubber with less friction; it is less affected by the amount of spin applied by the opponent.











BUTTERFLY RUBBER SPECIFICATION CHART

RUBBER	SURFACE	CATEGORY	SPEED	SPIN	DENSITY	SPONGE THICKNESS (MM)
Bryce	Inverted	High Tension Pimples-in Rubber	12.00	9.50	35	1.9, 2.1
Bryce FX	Inverted	High Tension Pimples-in Rubber	12.00	9.50	33	2.1
Bryce High Speed	Inverted	High Tension Pimples-in Rubber	14.50	10.30	35	1.9, 2.1
Bryce Speed	Inverted	High Tension Pimples-in Rubber	14.00	9.75	38	2.1
Bryce Speed FX	Inverted	High Tension Pimples-in Rubber	14.00	9.75	32	2.1
Challenger Attack	Pips-Out	Pimples-out Rubber	9.50	6.50	35	1.5, 1.9
Feint AG	Pips-Out	High Tension Long Pimpled Rubber	7.00	4.00	28	1.3, 1.7
Feint Long II	Pips-Out	Long Pimpled Rubber	6.25	3.25	38	0.5, 1.1, 1.3
Feint Long II OX	Pips-Out	Long Pimpled Rubber (without Sponge)	6.25	3.25	n/a	OX
Feint Long III	Pips-Out	Long Pimpled Rubber	6.00	4.00	25	0.5, 1.1, 1.3
Feint OX	Pips-Out	Long Pimpled Rubber (without Sponge)	4.50	3.50	n/a	OX
Feint Soft	Pips-Out	Long Pimpled Rubber	5.50	3.50	25	1.5
Flarestorm II	Pips-Out	High Tension Pimples-out Rubber	11.70	6.70	32	1.9, 2.1
Flextra	Inverted	Pimples-in Rubber	8.25	8.75	32	1.9
Impartial XB	Pips-Out	High Tension Pimples-out Rubber	11.90	6.70	30	1.7, 1.9, 2.1, MAX
Impartial XS	Pips-Out	High Tension Pimples-out Rubber	12.20	7.90	30	1.7, 1.9, 2.1, MAX
Orthodox	Pips-Out	Pimples-out Rubber (without Sponge)	6.00	4.25	n/a	OX
Raystorm	Pips-Out	High Tension Pimples-out Rubber	9.75	7.00	34	1.9, 2.1
Roundell	Inverted	High Tension Pimples-in Rubber	12.80	10.20	35	1.9, 2.1
Roundell Hard	Inverted	High Tension Pimples-in Rubber	12.80	10.20	40	2.1
Roundell Soft	Inverted	High Tension Pimples-in Rubber	12.80	10.20	32	2.1
Sapphira	Inverted	Pimples-in Rubber	8.75	8.50	35	1.9
Speedy PO	Pips-Out	Pimples-out Rubber	10.00	6.00	35	1.9
Spin Art	Inverted	High Friction High Tension Pimples-in Rubber	11.90	11.50	48	1.9, 2.1
Sriver	Inverted	Pimples-in Rubber	10.00	8.00	38	1.5, 1.7, 1.9, 2.1, MAX
Sriver EL	Inverted	Pimples-in Rubber	10.00	8.00	35	1.9, 2.1
Sriver FX	Inverted	Pimples-in Rubber	10.00	8.00	33	1.9, 2.1
Sriver G3	Inverted	High Tension Pimples-in Rubber	13.50	10.00	38	1.9, 2.1
Sriver G3 FX	Inverted	High Tension Pimples-in Rubber	13.50	10.00	32	2.1
Super Anti	Inverted	Anti-Spin Rubber	4.00	3.00	25	1.9
Tackifire C	Inverted	High Friction Pimples-in Rubber	8.50	11.00	41	1.7, 1.9, 2.1
Tackifire C Soft	Inverted	High Friction Pimples-in Rubber	8.50	11.00	34	1.9, 2.1
Tackifire Drive	Inverted	High Friction Pimples-in Rubber	9.00	9.25	38	2.1
Tackiness Chop	Inverted	High Friction Pimples-in Rubber	6.50	10.00	32	1.5, 1.7, 1.9
Tackiness Chop II	Inverted	High Friction Pimples-in Rubber	7.50	10.00	41	1.5, 1.9
Tackiness Drive	Inverted	High Friction Pimples-in Rubber	8.50	9.00	38	1.9
Tenergy 05	Inverted	High Tension Pimples-in Rubber	13.00	11.50	36	1.7, 1.9, 2.1
Tenergy 05 FX	Inverted	High Tension Pimples-in Rubber	13.00	11.50	32	1.9, 2.1
Tenergy 25	Inverted	High Tension Pimples-in Rubber	13.25	11.00	36	1.9, 2.1
Tenergy 25 FX	Inverted	High Tension Pimples-in Rubber	13.25	11.00	32	1.9, 2.1
Tenergy 64	Inverted	High Tension Pimples-in Rubber	13.50	10.50	36	1.9, 2.1
Tenergy 64 FX	Inverted	High Tension Pimples-in Rubber	13.50	10.50	32	1.9, 2.1
Tenergy 80	Inverted	High Tension Pimples-in Rubber	13.25	11.25	36	1.9, 2.1
Tenergy 80-FX	Inverted	High Tension Pimples-in Rubber	13.25	11.25	32	1.9, 2.1

ZHANG JIKE SZLC

The First Model with Super ZL-Carbon

SUPERZLC









ATTACK	5	FL  157x150mm	 5.6mm	 100x25mm
SHAKE	PLY			
12.3	11.1	AN  157x150mm	 5.6mm	 100x24mm
REACTION	VIBRATION			
	Regular	ST  157x150mm	 5.6mm	 100x23mm
	BLADE			



ZHANG JIKE ZLC

Highly-Balanced Model with ZL-Carbon

ZL CARBON









ATTACK	5	FL  157x150mm	 5.5mm	 100x25mm
SHAKE	PLY			
11.7	10.8	AN  157x150mm	 5.5mm	 100x24mm
REACTION	VIBRATION			
	Regular	ST  157x150mm	 5.5mm	 100x23mm
	BLADE			



ZHANG JIKE T5000

Speed-Minded Model with Carbon

TAMCA5000









ATTACK	5	FL  157x150mm	 5.6mm	 100x25mm
SHAKE	PLY			
12.6	11.3	AN  157x150mm	 5.6mm	 100x24mm
REACTION	VIBRATION			
	Regular	ST  157x150mm	 5.6mm	 100x23mm
	BLADE			



ZHANG JIKE ALC

High Performance Model with Arylate-Carbon

Arylate-CARBON

ATTACK	5	FL  157x150mm	 5.8mm	 100x25mm
SHAKE	PLY			
11.8	10.3	AN  157x150mm	 5.8mm	 100x24mm
REACTION	VIBRATION			
	Regular	ST  157x150mm	 5.8mm	 100x23mm
	BLADE			



ZHANG JIKE

World Champion, Zhang Jike's Model

Arylate-CARBON

ATTACK	5	FL  157x150mm	 5.8mm	 100x25mm
SHAKE	PLY			
11.8	10.3	AN  157x150mm	 5.8mm	 100x23mm
REACTION	VIBRATION			
	Regular	ST  157x150mm	 5.8mm	 100x23mm
	BLADE			









KENTA MATSUDAIRA ALC

Kenta Matsudaira's Model

New >>>

Arylate-CARBON

ATTACK	5	FL  157x150mm	 5.8mm	 100x23mm
SHAKE	PLY			
11.8	10.3	AN  157x150mm	 5.8mm	 100x23mm
REACTION	VIBRATION			
	Regular	ST  157x150mm	 5.8mm	 100x23mm
	BLADE			











FREITAS ALC

Designed in collaboration with Marcos Freitas

New >>>

Arylate-CARBON

ATTACK	5	FL  157x150mm	 6.0mm	 100x25mm
SHAKE	PLY			
11.4	10.8	AN  157x150mm	 6.0mm	 100x25mm
REACTION	VIBRATION			
	Regular	ST  157x150mm	 6.0mm	 100x23mm
	BLADE			











APOLONIA ZLC

Tiago Apolonia's Model

New >>>

immer fiber
ZL CARBON









ATTACK	5	FL  157x150mm	 5.7mm	 100x24mm
SHAKE	PLY			
10.5	9.5	AN  157x150mm	 5.7mm	 100x24mm
REACTION	VIBRATION			
	Regular	ST  157x150mm	 5.7mm	 100x23mm
	BLADE			



MIZUTANI JUN SZLC

Collaboration Model with Jun Mizutani

SUPERZLC









ATTACK	5	FL  157x150mm	 5.8mm	 100x24mm
SHAKE	PLY			
12.5	11.6	AN  157x150mm	 5.8mm	 100x22mm
REACTION	VIBRATION			
	Regular	ST  157x150mm	 5.8mm	 100x22mm
	BLADE			



MIZUTANI JUN ZLC

The Model Jun Mizutani Used

ZL CARBON

ATTACK	5	FL  157x150mm	 5.7mm	 100x24mm
SHAKE	PLY			
11.8	11.2	AN  157x150mm	 5.7mm	 100x24mm
REACTION	VIBRATION			
	Regular	ST  157x150mm	 5.7mm	 100x22mm
	BLADE			



TIMO BOLL ZLF

High Performance
Model with ZL-Fiber



ZL FIBER

ATTACK SHAKE	5 PLY	FL	157x 150mm	5.4mm	100x 24mm
REACTION	10.5	AN	157x 150mm	5.4mm	100x 24mm
VIBRATION	9.4	ST	157x 150mm	5.4mm	100x 22mm
BLADE	Regular				

TIMO BOLL T5000

Speed-Conscious
Model with
Distinguished Power



TAMCA 5000

ATTACK SHAKE	5 PLY	FL	157x 150mm	5.6mm	100x 24mm
REACTION	12.6	AN	157x 150mm	5.6mm	100x 24mm
VIBRATION	11.3	ST	157x 150mm	5.6mm	100x 22mm
BLADE	Regular				

TIMO BOLL W7

7-Ply Blade with Power
and Control



ATTACK SHAKE	7 PLY	FL	157x 150mm	6.8mm	100x 24mm
REACTION	11.4	AN	157x 150mm	6.8mm	100x 24mm
VIBRATION	10.0	ST	157x 150mm	6.8mm	100x 22mm
BLADE	Regular				

BOLL OFFENSIVE

Advanced All-Around Attack



ALL-ROUND SHAKE	5 PLY	FL	158x 150mm	6.0mm	100x 25mm
REACTION	10.9	AN	158x 150mm	6.0mm	100x 25mm
VIBRATION	8.7	ST	158x 150mm	6.0mm	100x 25mm
BLADE	Regular				

BOLL CONTROL

Beginner Control Stability



ALL-ROUND SHAKE	5 PLY	FL	158x 150mm	5.9mm	100x 25mm
REACTION	8.6				
VIBRATION	8.8				
BLADE	Regular				

TIMO BOLL ZLC

High Performance
Model with ZL-Carbon



ZL CARBON

ATTACK SHAKE	5 PLY	FL	157x 150mm	5.5mm	100x 24mm
REACTION	11.7	AN	157x 150mm	5.5mm	100x 24mm
VIBRATION	10.8	ST	157x 150mm	5.5mm	100x 22mm
BLADE	Regular				

TIMO BOLL ALC

Timo Boll's Model



Arylate-CARBON

ATTACK SHAKE	5 PLY	FL	157x 150mm	5.8mm	100x 24mm
REACTION	11.8	AN	157x 150mm	5.8mm	100x 24mm
VIBRATION	10.3	ST	157x 150mm	5.8mm	100x 22mm
BLADE	Regular				

TIMO BOLL SPIRIT

Model Which
Supported Timo Boll



Arylate-CARBON

ATTACK SHAKE	5 PLY	FL	157x 150mm	5.8mm	100x 24mm
REACTION	11.8	AN	157x 150mm	5.8mm	100x 24mm
VIBRATION	10.3	ST	157x 150mm	5.8mm	100x 22mm
BLADE	Regular				

BOLL ALLROUND

Immediate Controlled Power



ALL-ROUND SHAKE	5 PLY	FL	158x 150mm	5.8mm	100x 25mm
REACTION	9.6	AN	158x 150mm	5.8mm	100x 25mm
VIBRATION	8.3	ST	158x 150mm	5.8mm	100x 25mm
BLADE	Regular				

BOLL FORTE

Solid Balance Core
Construction



ALL-ROUND SHAKE	5 PLY	FL	158x 150mm	6.0mm	100x 25mm
REACTION	11.0				
VIBRATION	9.0				
BLADE	Regular				



GARAYDIA ZLC

Powerful High-Reaction Model with ZL-Carbon



ZL CARBON

ATTACK	3	FL	157x150mm	7.1mm	100x25mm
SHAKE	PLY	AN	157x150mm	7.1mm	100x25mm
REACTION	12.2	BLADE	Regular	ST	157x150mm
VIBRATION	13.7				100x23mm

GARAYDIA ALC

Consistency and Power Combined with Arylate-Carbon



Arylate-CARBON

ATTACK	3	FL	157x150mm	6.9mm	100x24mm
SHAKE	PLY	AN	157x150mm	6.9mm	100x24mm
REACTION	11.4	BLADE	Regular	ST	157x150mm
VIBRATION	13.0				100x23mm

INNERFORCE LAYER ZLF

New

Attack close to the table with abundant amount of rotation and stability



Inner fiber

ZL FIBER

ATTACK	5	FL	157x150mm	5.3mm	100x24mm
SHAKE	PLY	AN	157x150mm	5.3mm	100x24mm
REACTION	9.6	BLADE	Regular	ST	157x150mm
VIBRATION	7.9				100x22mm

INNERFORCE LAYER ALC

Well-Balanced Model with Bounce and Usability



Inner fiber

Arylate-CARBON

ATTACK	5	FL	157x150mm	6.0mm	100x25mm
SHAKE	PLY	AN	157x150mm	6.0mm	100x25mm
REACTION	10.7	BLADE	Regular	ST	157x150mm
VIBRATION	9.4				100x23mm

PHOTINO

Balance Between Bounce and Lightness

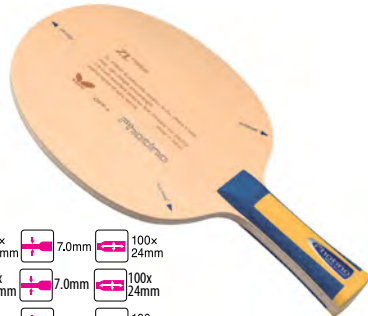

ZL FIBER

ATTACK	3	FL	157x150mm	7.0mm	100x24mm
SHAKE	PLY	AN	157x150mm	7.0mm	100x24mm
REACTION	11.5	BLADE	Regular	ST	157x150mm
VIBRATION	13.1				100x24mm



12 - BLADES

GARAYDIA T5000

Speed from Carbon Base



TAMCA 5000

ATTACK	3	FL	157x150mm	7.2mm	100x25mm
SHAKE	PLY	AN	157x150mm	7.2mm	100x25mm
REACTION	13.6	BLADE	Regular	ST	157x150mm
VIBRATION	14.5				100x23mm

LIU SHIWEN

Liu Shiwen's Model



Inner fiber

ZL FIBER

ATTACK	5	FL	158x152mm	5.6mm	100x24mm
SHAKE	PLY	AN	158x152mm	5.6mm	100x24mm
REACTION	9.7	BLADE	Regular	ST	158x152mm
VIBRATION	8.3				100x23mm

INNERFORCE LAYER ZLC

High Performance Model Balancing Power and Control



Inner fiber

ZL CARBON

ATTACK	5	FL	157x150mm	5.7mm	100x24mm
SHAKE	PLY	AN	157x150mm	5.7mm	100x24mm
REACTION	10.5	BLADE	Regular	ST	157x150mm
VIBRATION	9.5				100x23mm

INNERFORCE LAYER ALC.S

New

Similar to its predecessor with new plywood composition, Allows for Greater Spin



Inner fiber

Arylate-CARBON

ATTACK	5	FL	157x150mm	5.5mm	100x24mm
SHAKE	PLY	AN	157x150mm	5.5mm	100x24mm
REACTION	10.1	BLADE	Regular	ST	157x150mm
VIBRATION	8.4				100x23mm

AMULTART

High Performance Model with ZL-Carbon



ZL CARBON

ATTACK	3	FL	157x150mm	7.1mm	100x25mm
SHAKE	PLY	SI	157x150mm	7.1mm	100x25mm
REACTION	12.2	BLADE	Regular		
VIBRATION	13.7				

GIONIS CARBON ALLROUND

New

Allround play with Carbon precision



CARBON

ATTACK	5	FL	159x 152mm	5.7mm	100x 25mm
SHAKE	PLY				
10.2	8.0	AN	159x 152mm	5.7mm	100x 25mm
REACTION	VIBRATION				
Regular	Regular	ST	159x 152mm	5.7mm	100x 25mm
BLADE	BLADE				

HADRAW SK

7-Ply Blade for Range of Styles



ATTACK	7	FL	157x 150mm	6.4mm	100x 24mm
SHAKE	PLY				
10.0	8.6	AN	157x 150mm	6.4mm	100x 24mm
REACTION	VIBRATION				
Regular	Regular	ST	157x 150mm	6.4mm	100x 22mm
BLADE	BLADE				

HADRAW VK

5-Ply Blade for All-Round Play



ATTACK	5	FL	157x 150mm	5.7mm	100x 24mm
SHAKE	PLY				
10.5	8.4	AN	157x 150mm	5.7mm	100x 24mm
REACTION	VIBRATION				
Regular	Regular	ST	157x 150mm	5.7mm	100x 23mm
BLADE	BLADE				

PRIMORAC CARBON

Carbon with an Irresistible Power



TAMCA 5000

ATTACK	3	FL	157x 150mm	7.0mm	100x 25mm
SHAKE	PLY				
12.5	13.3	AN	157x 150mm	7.0mm	100x 23mm
REACTION	VIBRATION				
Regular	Regular	ST	157x 150mm	7.0mm	100x 23mm
BLADE	BLADE				

MAZE PERFORMANCE

Distinguished High-Level Performance



ATTACK	5	FL	157x 150mm	6.7mm	100x 24mm
SHAKE	PLY				
10.6	10.2	AN	157x 150mm	6.7mm	100x 24mm
REACTION	VIBRATION				
Regular	Regular	ST	157x 150mm	6.7mm	100x 24mm
BLADE	BLADE				

GIONIS CARBON OFFENSIVE

New

Direct offensive play



CARBON

ATTACK	5	FL	159x 152mm	6.2mm	100x 25mm
SHAKE	PLY				
11.0	8.8	AN	159x 152mm	6.2mm	100x 25mm
REACTION	VIBRATION				
Regular	Regular	ST	159x 152mm	6.2mm	100x 25mm
BLADE	BLADE				

HADRAW SR

Powerful Attack from High Reaction "Wenge" Wood



ATTACK	7	FL	157x 150mm	6.6mm	100x 24mm
SHAKE	PLY				
10.8	9.1	AN	157x 150mm	6.6mm	100x 24mm
REACTION	VIBRATION				
Regular	Regular	ST	157x 150mm	6.6mm	100x 23mm
BLADE	BLADE				

HADRAW VR

5-Ply All-Wood Blade for Powerful Attack



ATTACK	5	FL	157x 150mm	5.9mm	100x 25mm
SHAKE	PLY				
11.4	9.3	AN	157x 150mm	5.9mm	100x 25mm
REACTION	VIBRATION				
Regular	Regular	ST	157x 150mm	5.9mm	100x 23mm
BLADE	BLADE				

PRIMORAC

Blade with European Speed



ATTACK	5	FL	157x 150mm	5.5mm	100x 25mm
SHAKE	PLY				
9.7	7.6	AN	157x 150mm	5.5mm	100x 25mm
REACTION	VIBRATION				
Regular	Regular	ST	157x 150mm	5.5mm	100x 25mm
BLADE	BLADE				

MAZE MAGIC

Well suited for offensive play, with touch and control



ATTACK	5	FL	159x 151mm	5.9mm	100x 24mm
SHAKE	PLY				
9.5	8.5	AN	159x 151mm	5.9mm	100x 24mm
REACTION	VIBRATION				
Regular	Regular	ST	159x 151mm	5.9mm	100x 24mm
BLADE	BLADE				



A. MAZUNOV

All Wood Blade for Powerful Attacking



ATTACK	5	FL		158x152mm		6.7mm		100x25mm
SHAKE	PLY		AN		158x152mm		6.7mm	100x25mm
12.4	10.5	ST		158x152mm		6.7mm		100x23mm
REACTION	VIBRATION		BLADE	Regular				

SARDIUS

Carbon Blade for Powerful Attacking



TAMCA 5000	ATTACK	3	FL		158x152mm		7.2mm		100x25mm
		SHAKE		PLY	AN		158x152mm		7.2mm
12.8	14.4	Regular	ST		158x152mm		7.2mm		100x25mm
REACTION				VIBRATION	BLADE				

KORBEL SK7

7-Ply Blade Popular in Europe



ATTACK	7	FL		157x150mm		6.7mm		100x24mm	
	SHAKE		PLY	AN		157x150mm		6.7mm	100x24mm
11.1	9.3	Regular	ST		157x150mm		6.7mm		100x23mm
REACTION	VIBRATION			BLADE					

BALSACARBO X5

Wood Powered with Carbon Fibers

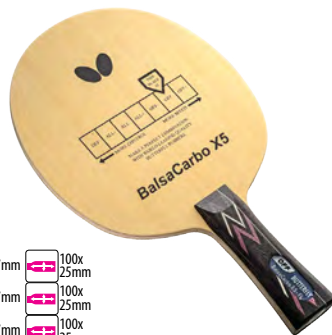

ATTACK	3	FL		159x150mm		6.7mm		100x25mm	
	SHAKE		PLY	AN		159x150mm		6.7mm	100x25mm
10.0	10.0	Regular	ST		159x150mm		6.7mm		100x25mm
REACTION	VIBRATION			BLADE					

Features of Materials for Blade

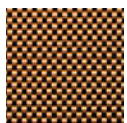

SUPER ZL CARBON

Super ZL-Carbon has 1.8 times as much densely woven Carbon-Fibers and ZL-Fibers in mass, as the existing ZL-Carbon by using special technology. The remarkable reaction and control provided by the expanded high-reaction area has taken the blade to the next stage.



ZL CARBON

ZL-Carbon is a woven combination of Carbon fiber and ZL-Fiber: Carbon fiber has a high reaction level and ZL-Fiber provides strength, elasticity and lightness. ZL-Carbon, the super fiber, gives the blade a high level of performance.



TAMCA 5000

Carbon (TAMCA-5000) is strong and light: six times stronger and one fifth in weight compared with iron and steel. Blades using TAMCA-5000 are light and strong with high elasticity and enable high performance.

VISCARIA

Excellent Balance for Flexibility and Bounce



Arylate-CARBON

ATTACK	5	FL		157x150mm		5.8mm		100x25mm	
	SHAKE		PLY	AN		157x150mm		5.8mm	100x25mm
11.8	10.3	Regular	ST		157x150mm		5.8mm		100x25mm
REACTION	VIBRATION			BLADE					

X-STAR IV

Model for Starters to Learn the ABC'S of Table Tennis



ALL-ROUND	5	FL		154x148mm		6.1mm		102x24mm	
	SHAKE		PLY	AN		154x148mm		6.1mm	102x24mm
10.0	10.1	Compact	ST		154x148mm		6.1mm		102x24mm
REACTION	VIBRATION			BLADE					

PETR KORBEL

Synonym for All-Wood 5-Ply Blade



ATTACK	5	FL		158x152mm		5.9mm		100x24mm	
	SHAKE		PLY	AN		158x152mm		5.9mm	100x24mm
10.6	8.2	Regular	ST		158x152mm		5.9mm		100x23mm
REACTION	VIBRATION			BLADE					

ANDRZEJ GRUBBA

Classic Control Still Popular Today



ALL-ROUND	5	FL		159x151mm		5.7mm		100x25mm	
	SHAKE		PLY	AN		159x151mm		5.7mm	100x25mm
9.7	7.9	11.7	ST		159x151mm		5.7mm		100x25mm
REACTION	VIBRATION			BLADE					



ZL FIBER

ZL-Fiber has a detailed molecular configuration that is strong and elastic. Its ratio is 10 percent lower than Carbon fiber, thus making the blade both light and with a high performance level.

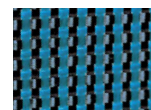

Arylate-CARBON

Arylate-Carbon is a special material created with a woven combination of Arylate and Carbon. Blades using Arylate-Carbon have power, speed and control.



Butterfly only uses Hinoki wood cut from trees over a hundred years old which grew on the northern side of the inclined plane of the Kiso Mountains, an area where trees are subject to less harmful rays from the sun. The wood grain is of vital importance for the Hinoki blade, a dense grain produces a good bounce.

GIONIS CARBON DEFENSIVE

New

Control and direct defensive play



CARBON

DEFENCE SHAKE	5 PLY	10.1 REACTION	7.8 VIBRATION	SEMI-LARGE BLADE	ST	164x157mm	5.9mm	100x25mm
---------------	-------	---------------	---------------	------------------	----	-----------	-------	----------

HADRAW SHIELD

Renowned for consistency in both Attack and Defence



DEFENCE SHAKE	5 PLY	7.9 REACTION	6.3 VIBRATION	SEMI-LARGE BLADE	FL	166x155mm	5.3mm	100x24mm
					ST	166x155mm	5.3mm	100x23mm

INNERSHIELD LAYER ZLF

Defensive Model with ZL-Fiber

Inner fiber ZL FIBER



DEFENCE SHAKE	5 PLY	5.5 REACTION	4.9 VIBRATION	SEMI-LARGE BLADE	FL	166x155mm	5.1mm	100x24mm
					ST	166x155mm	5.1mm	100x23mm

JOO SAEHYUK

Collaboration Model with Joo Saehyuk



DEFENCE SHAKE	5 PLY	10.4 REACTION	8.5 VIBRATION	SEMI-LARGE BLADE	FL	165x156mm	6.0mm	100x24mm
					ST	165x156mm	6.0mm	100x23mm

DEFENCE IV

Recommended for Defensive Techniques



DEFENCE SHAKE	3 PLY	9.8 REACTION	8.6 VIBRATION	SEMI-LARGE BLADE	FL	166x155mm	6.4mm	100x24mm
					ST	166x155mm	6.4mm	100x23mm

Isotype of Butterfly Blade

Playing Style

- ATTACK SHAKE** Shakehands grip blade for powerful top spin attacking players.
- ALL-ROUND SHAKE** Shakehands grip blade for all-round players whose aim is balanced and controlled play.
- DEFENCE SHAKE** Shakehands grip blade exclusively for defensive players; less bounce enables a stable defence to be combined with a fierce attack.
- TOP-SPIN-MINDED PEN** Penhold grip blade for the powerful attacking top spin player.
- QUICK ATTACK PEN** Penhold grip blade suitable for attack and defence, enables fast change from forehand and backhand.
- COMBINATION PEN** Combination penhold grip blade for players with different rubber surfaces on either side of the racket.

Reaction Property

10.0 REACTION The quantified reaction of blade: the higher the number, the more the reaction.

Vibration Property

10.0 VIBRATION The quantified vibration frequency: the higher the number, the less vibration you feel.

Blade Size (Shakehand)



Grip Shape (Shakehand)

- FL Flared** Gravity center is closer to grip and the blade fits in the palm.
- AN Anatomic** Wave-shape grip fits in the palm and provides stability.
- ST Straight** The straight grip enables to change a way of grip according to the play.

Blade Shape (Penhold)

- S** Angular Penhold Blade
- R** Round-Angular Penhold Blade
- CS** Chinese Penhold Blade

Size

- Width and length from the forefront to grip of shakehand and Chinese penhold blade.
- Blade thickness of shakehand and Chinese penhold blade.
- Grip thickness of shakehand and Chinese penhold blade.
- Width and length from the forefront to grip of Japanese penhold blade.
- Blade thickness of Japanese penhold blade.
- Length and height of upper part of Japanese penhold blade.

INNERFORCE LAYER ZLF

New

Attack close to the table with abundant amount of rotation and stability

inner fiber

ZL FIBER

QUICK ATTACK PEN	5 PLY
------------------	-------

9.6 REACTION	7.9 VIBRATION
--------------	---------------

CS	161x150mm	5.3mm	82x23mm
----	-----------	-------	---------



INNERFORCE LAYER ALC.S

New

Similar to its predecessor with new plywood composition, Allows for Greater Spin

inner fiber

Arylate-CARBON

QUICK ATTACK PEN	5 PLY
------------------	-------

10.1 REACTION	8.4 VIBRATION
---------------	---------------

CS	161x150mm	5.5mm	82x24mm
----	-----------	-------	---------



ZHANG JIKE SZLC

New

The First Model with Super ZL-Carbon

SUPER ZL-C

QUICK ATTACK PEN	5 PLY
------------------	-------

12.3 REACTION	11.1 VIBRATION
---------------	----------------

CS	161x150mm	5.8mm	82x24mm
----	-----------	-------	---------



TIMO BOLL ZLF

New

High Performance Model with ZL-Fiber

ZL FIBER

QUICK ATTACK PEN	5 PLY
------------------	-------

10.5 REACTION	9.4 VIBRATION
---------------	---------------

CS	157x150mm	5.4mm	82x24mm
----	-----------	-------	---------



TIMO BOLL ALC

New

Timo Boll's Model In a CS Handle

Arylate-CARBON

QUICK ATTACK PEN	5 PLY
------------------	-------

11.8 REACTION	10.3 VIBRATION
---------------	----------------

CS	157x150mm	5.7mm	82x24mm
----	-----------	-------	---------



16 - BLADES

INNERFORCE LAYER ZLC

High Performance Model
Balancing
Power and Control

inner fiber

ZL CARBON

QUICK ATTACK PEN	5 PLY
------------------	-------

10.5 REACTION	9.5 VIBRATION
---------------	---------------

CS	161x150mm	5.7mm	82x24mm
----	-----------	-------	---------



INNERFORCE LAYER ALC

New

Well-Balanced Model with
Bounce and Usability

inner fiber

Arylate-CARBON

QUICK ATTACK PEN	5 PLY
------------------	-------

10.7 REACTION	9.4 VIBRATION
---------------	---------------

CS	161x150mm	6.0mm	82x24mm
----	-----------	-------	---------



AMULTART

New

High Performance
Model with ZL-Carbon

ZL CARBON

QUICK ATTACK PEN	3 PLY
------------------	-------

12.2 REACTION	13.7 VIBRATION
---------------	----------------

CS	161x150mm	7.1mm	82x25mm
----	-----------	-------	---------



TIMO BOLL ZLC

New

High Performance
Model with ZL-Carbon

ZL CARBON

QUICK ATTACK PEN	5 PLY
------------------	-------

11.7 REACTION	10.8 VIBRATION
---------------	----------------

CS	157x150mm	5.5mm	82x24mm
----	-----------	-------	---------



PRIMORAC CARBON

New

Carbon with an
Irresistible Power

TAMCA5000

QUICK ATTACK PEN	3 PLY
------------------	-------

12.5 REACTION	13.3 VIBRATION
---------------	----------------

CS	161x150mm	6.9mm	82x25mm
----	-----------	-------	---------



SUPREME SPEED

Fast and precise for relentless attacks

New >>>



Arylate-CARBON

QUICK ATTACK PEN 3 PLY

REACTION 12.4 VIBRATION 14.3 CS 157x150mm 6.9mm 82x25mm

HADRAW VR

5-Ply Chinese Penhold for Powerful Attack



QUICK ATTACK PEN 5 PLY

REACTION 11.4 VIBRATION 9.3 CS 161x150mm 5.9mm 82x24mm

SHAMADA

Easy to Use Your Wrist



QUICK ATTACK PEN 5 PLY

REACTION 12.6 VIBRATION 12.6 CS 160x150mm 7.5mm 80x23mm

TAKSIM

One of our Most Popular Penhold Blades



Arylate-CARBON

QUICK ATTACK PEN 5 PLY

REACTION 12.6 VIBRATION 11.8 CS 158x150mm 7.0mm 82x24mm

YOSHIDA KAI

Kaii Yoshida's Model



QUICK ATTACK PEN 7 PLY

REACTION 11.1 VIBRATION 9.3 CS 161x150mm 6.8mm 82x25mm

STRAVE

Strike Bravely, Strave

New >>>



TAMCA5000

QUICK ATTACK PEN 3 PLY

REACTION 11.4 VIBRATION 12.2 CS 158x150mm 6.7mm 82x23mm

CHINESE REAL

Distinguished High Speed



QUICK ATTACK PEN 5 PLY

REACTION 11.6 VIBRATION 11.0 CS 158x150mm 7.7mm 82x24mm



CYPRESS JP I

1-Ply with Specially Selected Kiso Hinoki Wood

木曾檜
Kiso Hinoki

TOP-SPIN MINDED PEN	1
PLY	PLY

REACTION	12.8
VIBRATION	9.0

S	163x135mm	9.3mm	92x20mm
---	-----------	-------	---------



CYPRESS JP II

1-Ply Kiso Hinoki with Balanced Attack and Defence

木曾檜
Kiso Hinoki

TOP-SPIN MINDED PEN	1
PLY	PLY

REACTION	12.4
VIBRATION	8.8

S	163x135mm	9.0mm	92x20mm
---	-----------	-------	---------



GARAYDIA REVOLVER R

Combination Penhold for Attack and Defence close to the Table

Arylate-CARBON

COMBI-NATION PEN	3
PLY	PLY

REACTION	10.5
VIBRATION	8.2

R	161x141mm	6.4mm	86x16mm
---	-----------	-------	---------



CYPRESS JP III

1-Ply for Players of All Levels

木曾檜
Kiso Hinoki

TOP-SPIN MINDED PEN	1
PLY	PLY

REACTION	12.1
VIBRATION	8.8

S	163x135mm	8.7mm	92x20mm
---	-----------	-------	---------



HADRAW JPV R

Plywood Penhold Style for All Abilities

QUICK ATTACK PEN	5
PLY	PLY

REACTION	11.4
VIBRATION	10.7

R	161x141mm	7.1mm	92x20mm
---	-----------	-------	---------



RYU SEUNG MIN G-MAX

The Model for Ryu Seungmin

木曾檜
Kiso Hinoki

TOP-SPIN MINDED PEN	1
PLY	PLY

REACTION	13.8
VIBRATION	11.3

S	163x135mm	10.0mm	92x20mm
---	-----------	--------	---------



HADRAW JPV S

Plywood Penhold Style for All Abilities

TOP-SPIN MINDED PEN	5
PLY	PLY

REACTION	11.4
VIBRATION	10.7

S	163x135mm	7.1mm	92x20mm
---	-----------	-------	---------



RYU SEUNG MIN MAX

The Wonderful Power from the 10mm Thick Hinoki

木曾檜
Kiso Hinoki

TOP-SPIN MINDED PEN	1
PLY	PLY

REACTION	13.5
VIBRATION	11.3

S	163x135mm	10.0mm	92x20mm
---	-----------	--------	---------



HADRAW REVOLVER R

Easy to Use Combination Penhold Blade

COMBI-NATION PEN	5
PLY	PLY

REACTION	9.7
VIBRATION	9.0

R	161x141mm	5.9mm	86x16mm
---	-----------	-------	---------



BUTTERFLY SHAKEHAND BLADE SPECIFICATION CHART

BLADE	PLAYING STYLES	PLIES	REACTION	VIBRATION	WEIGHT (Grams)	BLADE DIMS (MM)		HEAD THICKNESS (MM)	HANDLE DIMS (MM)		
						H	W		AN	FL	ST
A. Mazunov	Attack Shake	5W	12.4	10.5	Avg. 102	158	152	6.7	100x25	100x25	100x23
Amultart	Attack Shake	3W+2ZLC	12.2	13.7	86	157	150	7.1	X	100x25	X
Andrzej Grubba	All-Round Shake	5W	9.7	7.9	85	159	151	5.7	100x25	100x25	100x25
Apolonia ZLC	Attack Shake	5W+2ZLC	10.5	9.5	89	157	150	5.7	100x24	100x24	100x23
Balsa Carbo X5	Attack Shake	3W+2C	8.7	9.0	80	159	150	6.7	100x25	100x25	100x25
Boll Allround	All-Round Shake	5W	9.6	8.3	85	158	150	5.8	100x25	100x25	100x25
Boll Control	All-Round Shake	5W	8.6	8.8	85	158	150	5.9	100x25	100x25	100x25
Boll Offensive	Attack Shake	5W	10.9	8.7	90	158	150	6.0	100x25	100x25	100x25
Boll Forte	Attack Shake	5W	11.0	9.0	90	158	150	6.0	100x25	100x25	100x25
Defence IV	Defense Shake	3W	9.8	8.6	87	166	155	6.4	X	100x24	100x23
Freitas ALC	Attack Shake	5W+2ALC	11.4	10.8	84	157	150	6.0	100x25	100x25	100x23
Garaydia ALC	Attack Shake	3W+2ALC	11.4	13.0	82	157	150	6.9	100x24	100x24	100x23
Garaydia T5000	Attack Shake	3W+2T5000	13.6	14.5	89	157	150	7.2	100x25	100x25	100x23
Garaydia ZLC	Attack Shake	3W+2ZLC	12.2	13.7	86	157	150	7.1	100x25	100x25	100x23
Gionis Carbon Allround	Attack Shake	5W+2C	10.2	8.0	85	159	152	5.7	100x25	100x25	100x25
Gionis Carbon Defensive	Attack Shake	5W+2C	10.1	7.8	85	164	157	5.9	X	X	100x25
Gionis Carbon Offensive	Attack Shake	5W+2C	11.0	8.8	90	159	152	6.2	100x25	100x25	100x25
Hadraw Shield	Defense Shake	5W	7.9	6.3	92	166	155	5.3	X	100x24	100x23
Hadraw SK	Attack Shake	7W	10.0	8.6	84	157	150	6.4	100x24	100x24	100x22
Hadraw SR	Attack Shake	7W	10.8	9.1	92	157	150	6.6	100x24	100x24	100x23
Hadraw VK	Attack Shake	5W	10.5	8.4	82	157	150	5.7	100x24	100x24	100x23
Hadraw VR	Attack Shake	5W	11.4	9.3	88	157	150	5.9	100x25	100x25	100x23
Innerforce Layer AL	Attack Shake	5W+2AL	9.4	8.6	79	157	150	5.9	100x25	100x25	100x23
Innerforce Layer ALC.S	Attack Shake	5W+2ALC	10.1	8.4	88	157	150	5.5	100x24	100x24	100x23
Innerforce Layer ALC	Attack Shake	5W+2ALC	10.7	9.4	85	157	150	6.0	100x25	100x25	100x23
Innerforce Layer ZLC	Attack Shake	5W+2ZLC	10.5	9.5	85	157	150	5.7	100x24	100x24	100x23
Innerforce Layer ZLF	Attack Shake	5W+2ZLF	9.6	7.9	86	157	150	5.3	100x24	100x24	100x22
Innershield Layer ZLF	Defense Shake	5W+2ZLF	5.5	4.9	85	166	155	5.1	X	100x24	100x23
Joo Saehyuk	Defense Shake	5W	10.4	8.5	101	165	156	6.0	X	100x24	100x23
Korbel SK7	Attack Shake	7W	11.1	9.3	92	157	150	6.8	X	100x24	X
Liu Shiwen	Attack Shake	5W+2ZLF	9.7	8.3	86	158	152	5.6	100x24	100x24	100x23
Matsudaira Kenta ALC	Attack Shake	5W+2ALC	11.8	10.3	85	157	150	5.8	X	100x23	X
Maze Magic	All-Round Shake	5W	9.5	8.5	85	159	151	5.9	100x24	100x24	100x24
Maze Performance	Attack Shake	5W	10.6	10.2	73	157	150	6.7	X	100x24	X
Mizutani Jun Super ZLC	Attack Shake	5W+2SZLC	12.5	11.6	90	157	150	5.8	X	100x24	100x22
Mizutani Jun ZLC	Attack Shake	5W+2ZLC	11.8	11.2	85	157	150	5.7	100x24	100x24	100x22
Petr Korbel	Attack Shake	5W	10.6	8.2	90	158	152	5.9	X	100x24	100x23
Photino	Attack Shake	3W+2ZLF	11.5	13.1	84	157	150	7.0	100x25	100x24	100x24
Primorac	Attack Shake	5W	9.7	7.6	84	157	150	5.5	X	100x25	X
Primorac Carbon	Attack Shake	3W+2T5000	12.5	13.3	89	157	150	7.0	X	100x25	100x23
Sardius	Attack Shake	3W+2T5000	12.8	14.4	92	158	152	7.2	X	100x25	X
Timo Boll ALC	Attack Shake	5W+2ALC	11.8	10.3	84	157	150	5.8	100x24	100x24	100x22
Timo Boll Spirit	Attack Shake	5W+2ALC	11.8	10.3	87	157	150	5.8	100x24	100x24	100x22
Timo Boll T5000	Attack Shake	5W+2T5000	12.6	11.3	90	157	150	5.6	100x24	100x24	100x22
Timo Boll W7	Attack Shake	7W	11.4	10.0	94	157	150	6.8	100x24	100x24	100x22
Timo Boll ZLC	Attack Shake	5W+2ZLC	11.7	10.8	84	157	150	5.5	100x24	100x24	100x22
Timo Boll ZLF	Attack Shake	5W+2ZLF	10.5	9.4	82	157	150	5.4	100x24	100x24	100x22
Viscaria	Attack Shake	5W+2ALC	11.8	10.3	85	157	150	5.8	X	100x25	X
X-Star IV	All-Round Shake	5W	10.0	10.1	78	154	148	6.1	X	102x24	X
Zhang Jike ALC	Attack Shake	5W+2ALC	11.8	10.3	86	157	150	5.8	102x24	100x25	100x23
Zhang Jike Super ZLC	Attack Shake	5W+2SZLC	12.3	11.1	87	157	150	5.6	102x24	100x25	100x23
Zhang Jike T5000	Attack Shake	5W+2T5000	12.6	11.3	90	157	150	5.6	102x24	100x25	100x23
Zhang Jike ZLC	Attack Shake	5W+2ZLC	11.7	10.8	86	157	150	5.5	102x24	100x25	100x23

BUTTERFLY PENHOLD SPECIFICATION CHART

BLADE	PLAYING STYLES	PLIES	REACTION	VIBRATION	WEIGHT (Grams)	BLADE DIMS (MM)		HEAD THICKNESS (MM)	HANDLE DIMS (MM)
						Avg.	H		
CHINESE STYLE									
Amultart CS	Quick Attack Pen	3W+2ZLC	12.2	13.7	84	161	150	7.1	82x25
Chinese Real	Quick Attack Pen	5W	11.6	11.0	77	158	150	7.7	82x24
Hadraw VR CS	Quick Attack Pen	5W	11.4	9.3	85	161	150	5.9	82x24
Innerforce Layer ALC.S CS	Quick Attack Pen	5W+2ALC	10.1	8.4	88	161	150	5.5	82x24
Innerforce Layer ALC CS	Quick Attack Pen	5W+2ALC	10.7	9.4	85	161	150	6.0	82x24
Innerforce Layer ZLC CS	Quick Attack Pen	5W+2ZLC	10.5	9.5	83	161	150	5.7	82x24
Innerforce Layer ZLF CS	Quick Attack Pen	5W+2ZLF	9.6	7.9	86	161	150	5.3	82x23
Primorac Carbon CS	Quick Attack Pen	3W+2T5000	12.5	13.3	84	161	150	6.9	82x25
Shamada	Quick Attack Pen	5W	12.6	12.6	84	160	150	7.5	80x23
Strave CS	Quick Attack Pen	3W+2T5000	11.4	12.2	74	158	150	6.7	82x23
Supreme Speed CS	Quick Attack Pen	3W+2ALC	12.4	14.3	79	157	150	6.9	82x25
Taksim	Quick Attack Pen	5W+2ALC	12.6	11.8	80	158	150	7.0	82x24
Timo Boll ALC CS	Quick Attack Pen	5W+2ALC	11.8	10.3	84	157	150	5.7	82x24
Timo Boll ZLC CS	Quick Attack Pen	5W+2ZLC	11.7	10.8	82	157	150	5.5	82x24
Timo Boll ZLF CS	Quick Attack Pen	5W+2ZLF	10.5	9.4	81	157	150	5.4	82x24
Yoshida Kaii	Quick Attack Pen	7W	11.1	9.3	91	161	150	6.8	82x25
Zhang Jike Super ZLC CS	Quick Attack Pen	5W+2SZLC	12.3	11.1	84	161	150	5.6	82x24
JAPANESE STYLE									
Cypress JP III	Top-Spin-Minded Pen	1W	12.1	8.8	83	163	135	8.7	92x20
Cypress JP II	Top-Spin-Minded Pen	1W	12.4	8.8	86	163	135	9.0	92x20
Cypress JP I	Top-Spin-Minded Pen	1W	12.8	9.0	87	163	135	9.3	92x20
Garaydia Revolver	Combination Pen	3W+2ALC	10.5	8.2	57	161	141	6.4	86x16
Hadraw JPV R	Quick Attack Pen	5W	11.4	10.7	78	161	141	7.1	92x20
Hadraw JPV S	Top-Spin-Minded Pen	5W	11.4	10.7	77	163	135	7.1	92x20
Hadraw Revolver	Combination Pen	5W	9.7	9.0	62	161	141	5.9	86x16
Ryu Seung Min G-Max	Top-Spin-Minded Pen	1W	13.8	11.3	87	163	135	10.0	92x20
Ryu Seung Min Max	Top-Spin-Minded Pen	1W	13.5	11.3	97	163	135	10.0	92x20

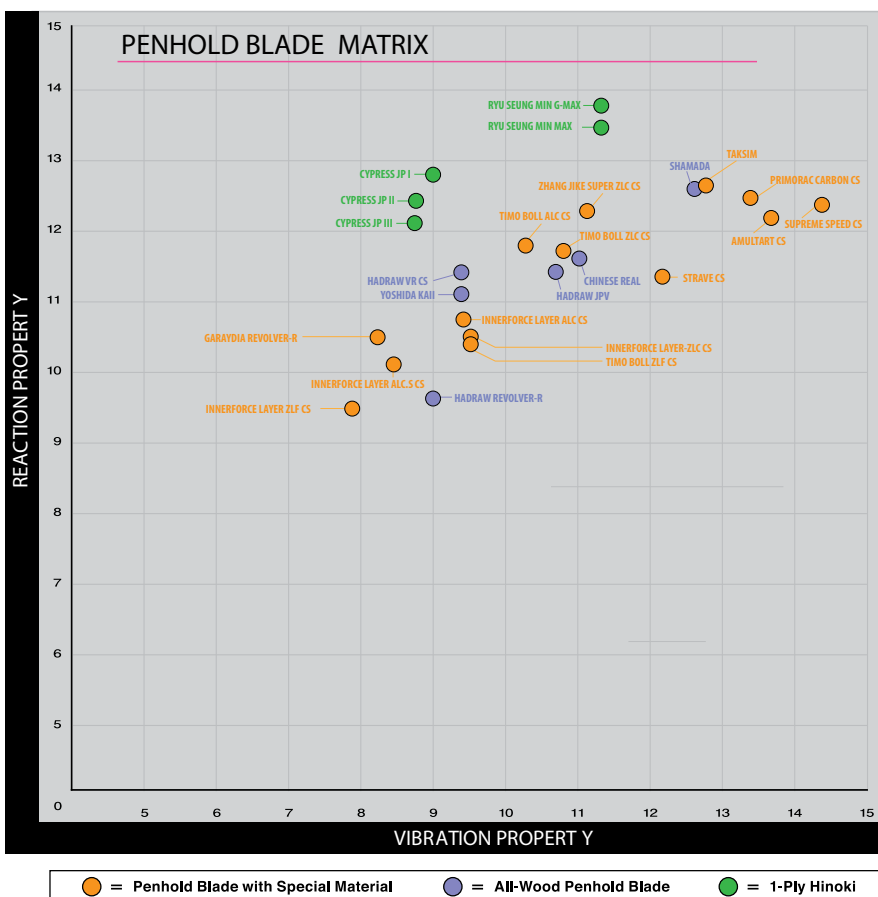

Matrix of BUTTERFLY blades comparing material REACTION and VIBRATION

REACTION PROPERTY:

The Quantified Reaction of Blade: the bigger the number, the more the reaction.



REACTION PROPERTY



VIBRATION PROPERTY:

The Quantified Vibration Frequency: the higher the number, the less vibration you feel.



VIBRATION PROPERTY



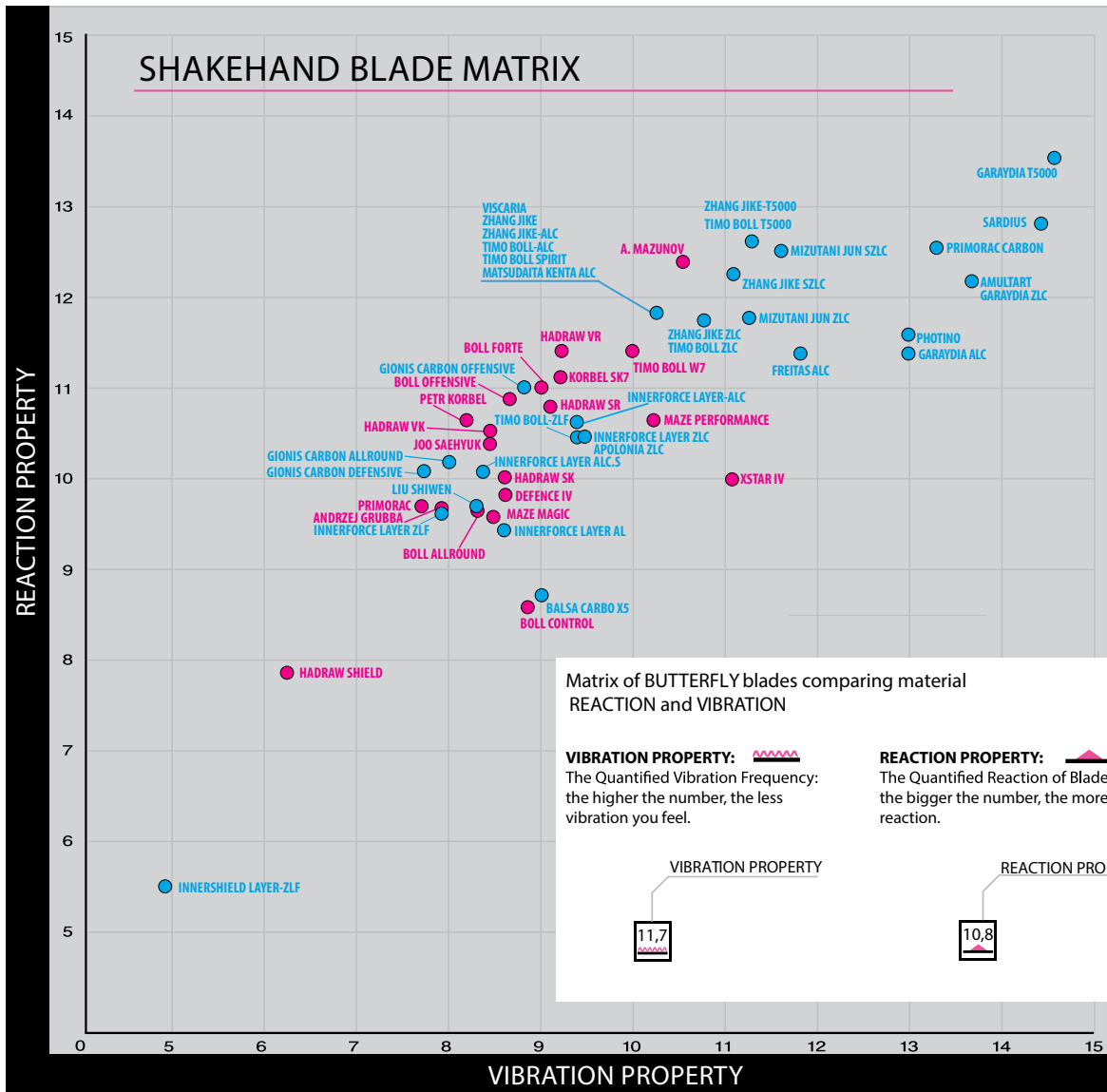

PLAYING STYLE

ATTACK SHAKE

Shakehands grip blade for power top spin attacking players.

ALL-AROUND SHAKE

Shakehands grip blade for all-around players whose aim is balanced and controlled play.

DEFENCE SHAKE

Shakehands grip blade exclusively for defensive players; less bounce enables a stable defence to be combined with a fierce attack.

QUICK ATTACK PEN

Penhold grip blade suitable for attack and defence, enables fast reaction change from forehand and backhand.

TOP-SPIN MINDED PEN

Penhold grip blade for the powerful attacking top spin player.

COMBI-NATION PEN

Combination Penhold grip blade for players with different rubber surfaces on either side of the racket.

BLADE DIMENSIONS



Width and length from the forefront to grip of the blade

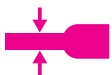

Blade thickness of the shakehand and penhold blades



Grip thickness of shakehand and penhold blade

REACTION PROPERTY



REACTION

The quantified reaction of blade: the higher the number, the more reaction

VIBRATION PROPERTY



VIBRATION

The quantified vibration frequency: the higher the number the less vibration you feel

GRIP SHAPE

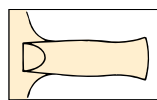

AN

Anatomic:
Wave-shape grip fits the palm and provides stability

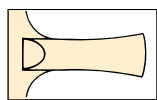

FL

Flared:
Gravity center is closer to grip and the blade fits in the palm

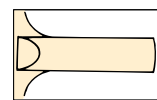

ST

Straight:
The straight grip enables to change a way of grip according to the play

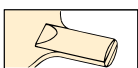

CS

Chinese Penhold Blade

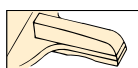

JP

Japanese Penhold

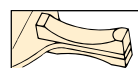

COMBINATION

Combination Penhold

HEAD SHAPE (PENHOLD)

S – Angular Penhold Blade

R – Round-Angular Penhold Blade



ZHANG JIKE BOX SET



Made with Carbon Fibers.
Comes with a Free Racket Case!

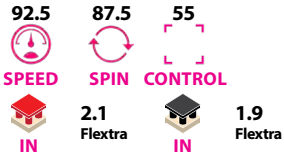

BTY 603



Comes with a Free Racket Case!

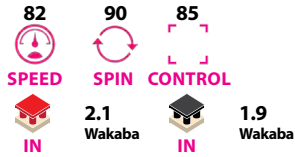

BTY 501



Comes with a Free Racket Case!

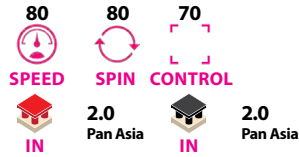

BTY 401



Comes with a Free Racket Case!

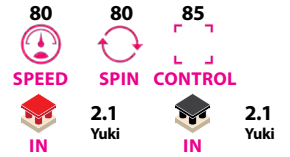

BTY 303



Comes with a Free Racket Case!

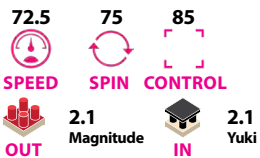

BTY 302



Comes with a Free Racket Case!

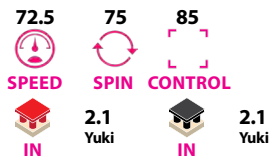

BTY 201



Comes with a Free Racket Case!

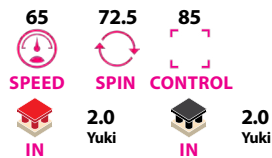

ARBALEST

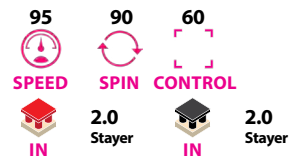

SPATHA

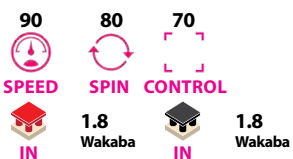

RANSEUR

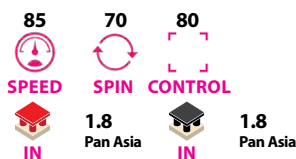

BASELARD

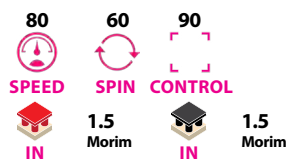

FLAIL

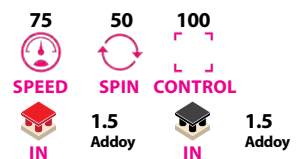

ADDOY 1000

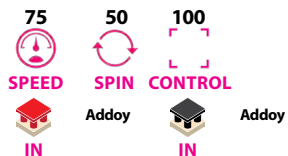

WAKABA 1000

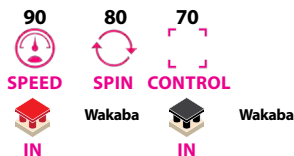

TIMO BOLL 1000

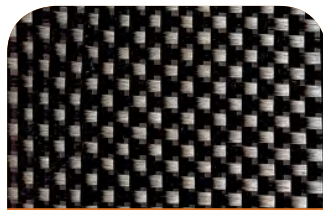
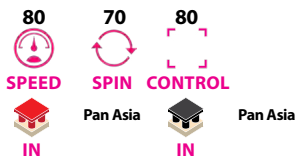

CARBON

Carbon fiber layers will add more speed to a racket and it will also increase the size of the sweet-spot, making the racket more consistent.

ADDOY 2000

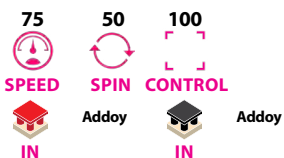

WAKABA 2000

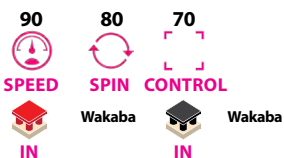

TIMO BOLL 2000



TIMO BOLL CF 1000



Made With Carbon Fiber!



ADDOY 3000

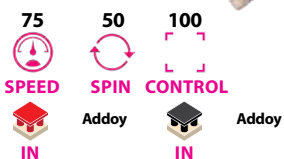

WAKABA 3000

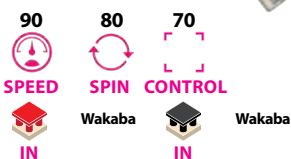

TIMO BOLL 3000

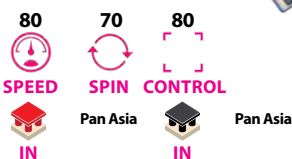

TIMO BOLL CF 2000



Made With Carbon Fiber!



YARI



80 SPEED
75 SPIN
75 CONTROL
1.8 Wakaba IN

JIAN



55 SPEED
35 SPIN
100 CONTROL
1.5 Addoy IN

PREASSEMBLED PLAYING SETS

Enjoy playing table tennis with the family by playing with one our Victory playing sets, or get in even more exercise with a set of the high-paced, Aerobic Table Tennis sets.

BTY 302-CS



72.5 SPEED
75 SPIN
85 CONTROL
2.1 Yuki IN

BTY 303-CS



72.5 SPEED
75 SPIN
85 CONTROL
2.1 Magnitude OUT
2.1 Yuki IN

VICTORY SETS



75 SPEED
50 SPIN
100 CONTROL
Addoy IN

BTY-CS 1000



80 SPEED
70 SPIN
80 CONTROL
Pan Asia IN

BTY-CS 2000



80 SPEED
70 SPIN
80 CONTROL
Pan Asia IN

AEROBIC TABLE TENNIS



ADHESIVE RUBBER PROTECT FILM III

- Protects rubber from dirt
- Tackier than rubber film
- Includes two Sheets



CLEAN CARE

- Cleaning sponge in its own case
- Soft sponge is attached to the lid
- Cover easily screws closed
- Keeps your hands and bag clean



CLEAN BRUSH

- Cleaner for all pips rubber



PIPS BRUSH

- Cleaner for all pips rubber



COTTON SPONGE

- Thick cleaning sponge with soft cotton covering
- Perfect gentle cleaning in combination with our special cleaners



RUBBER CARE SPONGE

- Cleaning sponge for rubber
- Yellow side for regular cleaning
- Blue side for intense cleaning



GLUE REMOVER

New



- For optimal removal of glue residue on blade and sponge surfaces
- Intended for use with Butterfly free chack (the Butterfly remover is not guaranteed to work on all rubbers)

RACKET CARE KIT

- A must for the serious player
- The kit includes: butterfly foam cleaner, rubber care sponge and cleaning tips
- The specially formulated cleaner will help rejuvenate the rubber surface to its natural tacky state
- The cleaning sponge offers a soft absorbent side and a very dense side that acts as a squeegee



RUBBER FILM III



- Durable plastic film designed to protect the rubber surface
- Contains two sheets

COMBI CLEANER

- Revitalize your rubber surface
- Easy application with built-in sponge tip
- 100ml



CURE WATER

- Spray pump
- Non-toxic
- Non-flammable
- 150ml



SPIN REFRESH

- Environmentally friendly and non-gas type foam cleaner
- 150ml



RUBBER CLEANER

- Bring your rubber back to life to its naturally tacky state
- Specially formulated to rejuvenate your rubber surface
- Pump spray top
- 250ml



FREE CHACK II

- Newly formulated, latex based adhesive
- Specifically designed for spring sponge rubbers, Spinart and the Tenergy series of rubbers
- Allows easy removal of excess glue from sponge and blade surface
- Stronger bond than free chack
- Made in Japan



FREE CHACK

- 100% Liquidized natural caoutchouc
- Easy to remove from sponge and racket
- 37ml bottle approximately 20 Applications, includes 8 sponges & a clip
- 90ml bottle approximately 50 Applications, includes 15 sponges & a clip
- 500ml bottle approximately 270 Applications, includes 50 sponges & a clip



CHACK SHEET

- Transparent glue sheet
- 1 Sheet, two adhesive sides



RACKET SHEET

- Colored racket sheets
- Adhesive back for penhold blades
- Available in black and red



OVERGRIP SOFT TAPE New

- High sensitivity material enhances the feeling of the handle
- Maximum sweat Absorption and non-slip Profile
- Embossed butterfly Logo grip
- Pu surface, elasticated Micro-fiber base
- Quantity: 3 pieces



CLIP SPONGE



- The clip sponge is intended to use with free chack or free chack II
- Easily applies a thin, even layer of glue to the blade and sponge
- Each set contains 10 sponges and 1 clip

POWER TAPE

- Adds Weight To Racket
- Five One Gram Pieces
- 6mm X 76mm



RB PROTECTOR II

- Covers one racket
- Size: 10mm x 50cm



SOFT GRIP TAPE



- Adds comfort and thickness
- Excellent sweat absorption

SIDE TAPE CLOTH / TENERGY SIDE TAPE

- Length: 1m = 2 rackets
10m = 20 rackets
50m = 100 rackets
- Colors:
 - Black/white
 - Blue/pink (50m x 6m, 9mm)
 - Blue/silver (10m x 12mm, 50m x 12mm)
- Tenergy side tape
- Color: orange
- Size: 50m x 12mm, 10mx 12mm)



RUBBER GRIP



- Adds comfort and thickness
- Prevents slippage



ALU CASE

- Maximum protection for your racket and balls
- Ridged aluminum outer structure with foam inner lining
- Holds one racket and 3 balls



LOGO FULL CASE **New**

- Racket shaped case with zipper closure
- Padded front and back panels



LOGO TOUR CASE **New**

- Designed to hold two rackets and four balls
- Simple, clean design
- Padded front and back panels with an inside pouch



BL TOUR CASE

- The bl tour case is designed to hold two rackets and four balls
- Made of polyester with padded front and back panels
- Zipper accessory pouch and zippered closure



NELOFY DX CASE

- Plenty of room for your rackets and care products
- Accommodates two rackets and four balls
- Two separate compartments with blade divider



NELOFY TOUR CASE

- Accommodates two rackets and four balls
- Accessory pouch on inside back panel
- High quality zipper with functional carrying strap



NL HARD FULL CASE

- Durable Plastic Material
- Holds 1-2 Rackets
- Internal Mesh Pocket
- Zipper with Carrying Strap



PRO DX CASE **New**

- Designed to hold two rackets
- Two separate zippered compartments with racket pockets
- Made of polyester with padded front and back panels
- Back accessory pouch with Velcro



PRO TOUR CASE **New**

- Designed to hold two rackets
- One zippered compartment with two internal pockets to separate rackets
- Made of polyester with padded front and back panels



PRO FULL CASE **New**

- Offers great protection for your racket
- Accessory/ball pouch with zipper
- Made of polyester with padded front and back panels
- All around zipper closure



TRESNAL DX CASE

- Plenty of room for your racket and care products
- Accommodates two rackets and four balls with additional pouch for accessories
- High quality zippers with functional carrying strap



TRESNAL TOUR CASE

- The tresnal tour case is designed to hold two rackets and four balls
- Made of durable nylon with padded front and back panels
- Accessory pouch on inside back panel
- Zipper closure



TRESNAL FULL CASE

- The tresnal full case offers great protection for your racket
- Simple, clean design
- Padded front and back panels



TRESNAL HEAD CASE

- The tresnal head case offers great protection for your racket
- Simple, clean design
- Padded front and back panels



NELOFY SHOULDER BAG

- Looks Great in Daily Use for all Documents, Laptops and Other Training-Related Material
- Bottle Compartment and Two Zip Lock Outer Pockets



NELOFY DUFFLE BAG

- Clever and Flexible Duffle Bag for Table Tennis and Fitness Training
- Foldable Design Ensures the Best Mobility
- Interior Provides Enough Space for the Equipment



NELOFY SPORT BAG

- Makes a Brilliant Appearance Anywhere with its Fresh Design
- Adjustable Straps
- Provides More than Enough Interior and Exterior Space for Daily Training



NELOFY RUCKSACK

- Sporty Companion for Daily Use
- Featuring Spacious and Clever Interior Design
- Zip Lock Outer Pocket and Two Additional Side Pockets



NELOFY MAXI BAG

- Maximum Space for Extended Trips and Big Tournaments
- More than Spacious Main Compartment Provides Space for All Necessary Equipment



NELOFY TROLLEY

- Perfect Carry-On Companion for Short Trips
- Large Main Compartment with Ample Storage Space and Outer Pockets
- Durable In-Line Skate Style Wheels



TABLE FAQ

TOP



Simply put, the thicker the top, the better the bounce. A wood top that is at least 1/2" thick is suitable for home or recreational play. Many institutional tables are 5/8" to 3/4" thick. Almost all professional quality tables are a minimum of 7/8" to 1" thick.

RAIL

A heavy gauge steel rail will reinforce the structure of the table and provide additional support. It also serves a cosmetic purpose, adding to the beauty of your table.

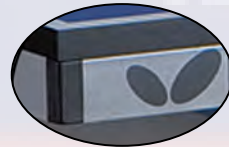

LEGS

Heavy gauge steel legs provide a solid foundation for your table. Round legs are sufficient, but square legs are more structurally sound.



NET

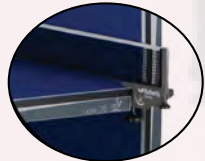

All of our tables come with a net set. Our Home and Outdoor use tables offer a basic net. The Institutional and Professional level models are equipped with a higher quality cloth net which clamps directly to the table and features heavy duty brackets with padded clamps that help protect the surface of the table. These nets also offer a dual precision height adjuster.

PLAYBACK POSITION

Most models allow you to fold up one half of the table and use it as a backboard. This will quicken reflexes and sharpen hand-eye coordination. A great feature for the kids.



ADJUSTABLE FEET



Many of our Institutional and Professional level tables have adjustable feet. This will ensure that the table is level, even when the floor is not.

ACCESSORY HOLDER

Some models feature a convenient accessory holder that is integrated into the frame of the table. It will accommodate multiple rackets and balls. This system also allows the net to remain attached to the table during play as well as in the storage position.

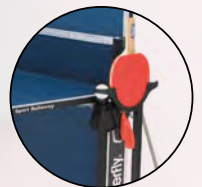

DIMENSIONS

Measure your intended playing area before ordering a table. In the play position, the table measures 9' long by 5' wide. The net brackets will add approximately 1' to the width of the table. An additional 5' on each side of the table will allow a comfortable distance for play. Storage height will vary, so be sure to check the product descriptions for more information.

It is also a good idea to measure all doorways, hallways and stairwells that the table may encounter prior to reaching its final destination.

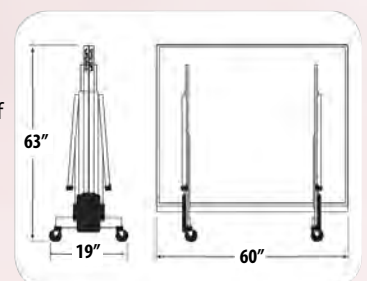

TABLE SPEC CHART

TABLE SPECIFICATIONS		TOP THICKNESS	RAIL / RIM	LEGS	WHEELS	PRODUCT WEIGHT (lbs.)	SHIPPING WEIGHT (lbs.)	PLAYBACK POSITION	ADJUSTABLE FEET	ACCESSORY HOLDER	HASSLE FREE NET	WARRANTY (YEARS)	STORAGE DIMENSIONS
PROFESSIONAL	Centrefold 25	1"	2" x 3/4" Steel	2" Square	5"	280	385	X	✓	X	X	5	63"x60"x19"
	Octet 25 Rollaway	1"	2" x 3/4" Steel	2" Square	4"	275	380	✓	✓	X	X	5	60"x55"x6"
	Europa 25	1"	2" x 3/4" Steel	2" Square	5"	270	375	X	X	X	X	5	63"x64"x25"
	Space Saver 22	7/8"	2" x 3/4" Steel	1 3/8" Square	3"	215	375	X	✓	X	X	5	63"x60"x19"
INSTITUTIONAL	Nippon Rollaway	7/8"	2" x 3/4" Steel	2" Square	5"	265	370	✓	X	X	X	5	73"x60"x30"
	Club 25 Rollaway	1"	1 1/2" Steel	2 3/8" Square	4"	265	370	✓	✓	X	✓	3	61"x72"x26"
	Match 22 Rollaway	7/8"	1 1/2" Steel	1 3/16" Square	4"	230	235	✓	✓	X	X	3	68"x63"x24"
	Premium Rollaway	3/4"	1 1/2" x 3/8" x 1 1/2" Steel	1 1/8" Square Steel	4"	205	210	✓	✓	X	X	3	68"x63"x28"
	Easifold 19 Rollaway	3/4"	1 1/8" x 3/4"	1" x 1 5/8" Steel	2 3/4"	177	203	✓	✓	X	X	3	68"x63"x28"
	Playback Rollaway	3/4"	1 1/2" Steel	1" Square Steel	5"	170	180	✓	X	✓	✓	3	74"x71"x25"
	Personal Rollaway	3/4"	1 1/2" Steel	1" Round Steel	5"	170	180	✓	X	✓	✓	3	74"x71"x25"
HOME	Compact 19	3/4"	1 1/8" x 3/4"	1 1/8" Square Steel	2"	167	187	X	X	X	X	3	54"x60"x5"
	Sport Rollaway	3/4"	N/A	1" Round Steel	5"	150	160	✓	X	✓	✓	3	65"x61"x29"
	Junior	1/2"	7/8" x 5/8"	3/4" Square Steel	2"	62	71	X	X	X	X	3	42"x45"x3"
	Fun	1/2"	N/A	3/4" Round Steel	N/A	44	49	X	X	X	X	3	28"x45"x3"
	PT Conversion Tops	3/4"	1 1/2" Steel	N/A	N/A	150	160	X	X	X	X	3	53"x60"x5"
	Easifold Outdoor	1/2"	1 1/8" x 3/4"	1" x 1 5/8" Steel	2 3/4"	209	225	✓	✓	X	X	3	63"x63"x25"
OUTDOOR	Outdoor Playback Rollaway	1/4"	1 1/2" Steel	1" Square Steel	5"	140	150	✓	X	✓	✓	3	74"x71"x25"
	Compact Outdoor	1/2"	1 1/8" x 3/4"	1 1/8" Square Steel	2"	178	201	X	X	X	X	3	60"x54"x5"
	Sport Outdoor Rollaway	3/16"	1 1/2" Steel	1" Round Steel	5"	108	118	✓	X	✓	✓	3	65"x61"x29"



CENTREFOLD 25

- Official Table of the We Are Butterfly club program
- Buy Used and Save!



EUROPA 25

- Official Table of the We Are Butterfly club program
- Buy Used and Save!



OCTET

- Official Table of the We Are Butterfly club program



NIPPON

- Classic compliment to any game room



CLUB 25

- Our least expensive 1" top

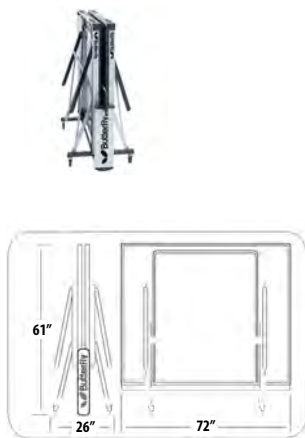

SPACE SAVER 22

- Features the same compact design as our flagship model, the Centrefold 25



MATCH 22

- Ideal for budget minded table tennis clubs



PREMIUM ROLLAWAY

- Great Table for Institutional Use



EASIFOLD 19 ROLLAWAY

- New Quick Assembly Table Design

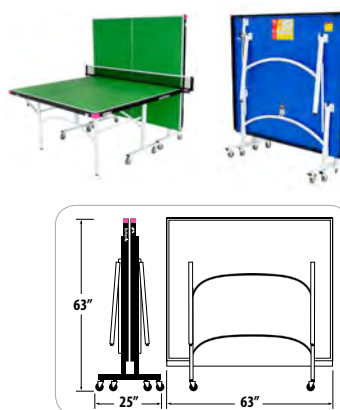

PLAYBACK ROLLAWAY

- Heavy-Duty Home Use

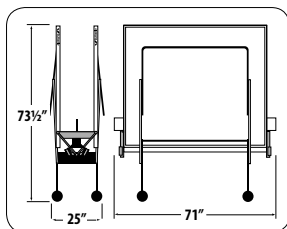

COMPACT 19

- No Assembly Required

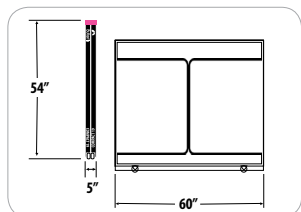

PERSONAL ROLLAWAY

- Our Best Seller

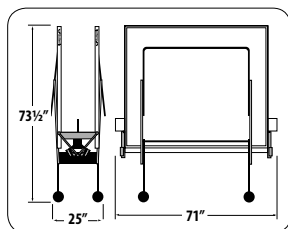

SPORT ROLLAWAY

- User Friendly Indoor Design

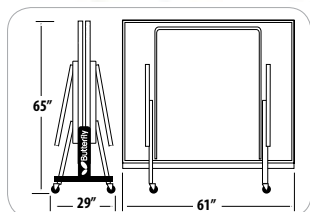

JUNIOR

- ¾ Sized Table
- Table Dimensions:
In Use:
81" long x 45" wide x 30" high
Storage:
44½" long x 3" wide x 41½" high

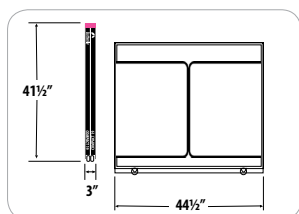

FUN

- Table Tennis on the Go
- Table Dimensions:
In Use:
54½" long x 36¼" wide x 24" high
Storage:
44½" long x 3" wide x 28" high

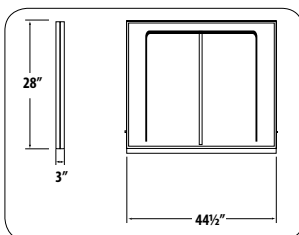

COMPACT OUTDOOR

- Compreg Top Offers Superior Outdoor Bounce

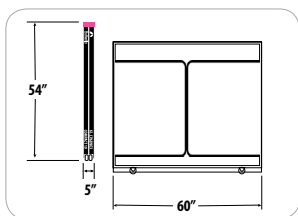

OUTDOOR PLAYBACK

- Our Most Popular Outdoor Table of All Time

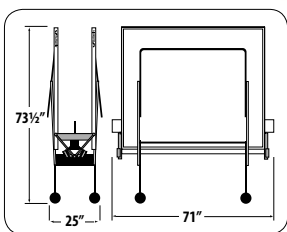

EASIFOLD OUTDOOR

- Compreg Top Offers Superior Outdoor Bounce

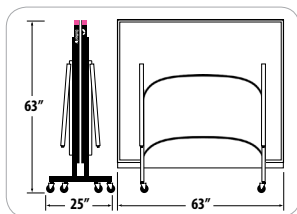

SPORT OUTDOOR

- User Friendly Indoor/Outdoor Design

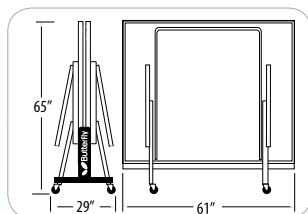

BALL AMIGO / REPLACEMENT HEAD

- Compliment to the ball trainer
- Easy pick up of balls
- Adjustable, telescoping handle
- Saves your back for the matches
- Replace worn net or dented frame for ball amigo

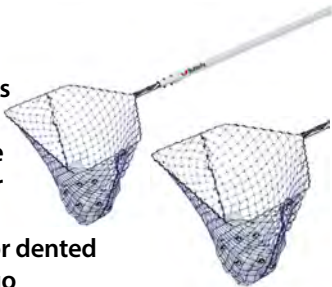

BALL TRAINER

- Ball holder used for training
- Adjustable height
- Four wheels allow for easy transport



UMPIRE TABLE

- Large, flat surface for displaying scoreboard
- Great for spectator events
- Collapses flat when not in use
- Carrying handle
- Buy tournament used and save!



BALL BAG

- Holds more than 200 40mm balls
- Great for multi-ball training
- Material: polyester 210 d
- Dimensions: 22.5 X 22.5 X 40cm



TABLE CLEANER

- A liquid developed using latest biological techniques
- Stainless removal of dust, dirt, and grease from the table's surface



TABLE COVER

- Protect and prolong the life of your table
- Made of durable nylon
- Zippers allow you to cover the table during storage or play positions
- Size: 60.5"X29.5"59"



LEAGUE SCORER

- Scoreboard stands upright inside the box top
- Includes time-out card
- Game score to 25
- Set score to 5
- Size 18.5"X11.8"X11.8"
- Buy tournament used and save!



TOWEL & BALL BOX

- Adds a professional look to your club or game room
- Made of heavy gauge corrugated cardboard
- Can also be used for multi-ball practice
- Hexagonal shaped with butterfly logo
- Stands 30" tall
- Buy tournament used and save!



TOWEL & BALL BOX

- Adds a professional look to your club or game room
- Made with a wood storage bin and a metal base
- Can also be used for multi-ball practice
- Hexagonal shaped with butterfly logo
- Stands 30" tall



DUO SCORER

- Two full size scorers in one!
- Space saving, functional & Extremely stable
- Size: 15.3"X10.2"X10.2"



EUROPA BARRIER

- Butterfly logo on one side
- Size: 7'8"x2'4"
- Buy tournament used and save!

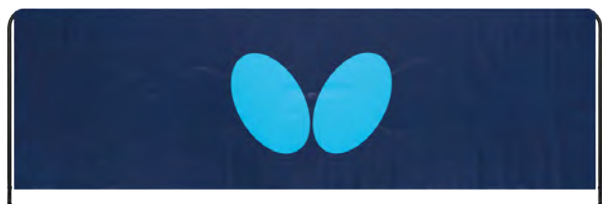

EUROPA BARRIER DOUBLE BRACE

- Butterfly logo on one side
- Size: 7'8"x2'4"





TOURNAMENT USED TABLES & EQUIPMENT

**CENTREFOLD
25**



EUROPA 25



**EUROPA
BARRIER**



BUTTERFLY

**OFFICIAL EQUIPMENT
SUPPLIER FOR THE:**

- 2017 BUTTERFLY NORTH AMERICA TOUR
- 2017 BUTTERFLY CANADA CUP VANCOUVER
- 2017 BUTTERFLY CANADA CUP MARKHAM
- 2017 BUTTERFLY ARNOLD CHALLENGE
- 2017 BUTTERFLY CANADA CUP FINALS
- 2017 AMERICA'S TEAM CHAMPIONSHIP
- 2017 NATIONAL SENIOR GAMES
- 2017 BUTTERFLY CANADIAN CHAMPIONSHIPS
- 2017 BUTTERFLY SAN FRANCISCO OPEN
- 2017 BUTTERFLY BADGER OPEN
- 2017 BUTTERFLY SOUTHEASTERN OPEN
- 2017 BUTTERFLY TEAMS
- 2017 BUTTERFLY CALIFORNIA OPEN @ ICC

**UMPIRE
TABLE**



**TOWEL &
BALL BOX**



**LEAGUE
SCORER**



EUROPA NET SET

- Highest quality net set
- Screw on felt tipped clamps
- Ring chain to adjust net tension
- Adjustable screws to calibrate net
- Fits tables up to 1.5"



NATIONAL LEAGUE NET SET

- Highest quality net set
- Fits tables up to 1.75"



ELITE CLIP NET SET

- Low priced metal net set with height and tension adjustments
- Easy handling for daily use in home or club
- Black textile net



STALLION NET SET

- Rubber felt padded brackets and clamps
- Fits tables up to 1.75"
- Includes net height measure
- Adjustable net tension



PERFECT II NET SET

- Perfect II Net Set: Full replacement net set for the Personal, Playback and Outdoor Playback table models



CLUB NET SET

- Full replacement net set for the Home and Outdoor Home table models



ELITE OUTDOOR NET SET

- Replacement Net Set for Compact & Easifold Outdoor Tables



CLIP NET SET

- Replacement Net Set for Compact & Easifold Indoor Tables



ECONOMY CLIP NET SET

- Replacement Net Set for Junior Tables



FUN NET

- Replacement Net for Fun Table

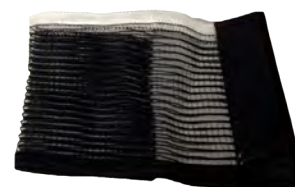

REPLACEMENT NET & BARS

- Fits National League, Europa, and Stallion Net Sets
- 72" Long



REPLACEMENT NET

- Replacement Net for National League, Europa, Stallion, and Elite Clip Net Sets
- 72" Long



NET GAUGE

- Net Height Measure
- Steel
- Weight: 100g



3-STAR G40+

- The new ITTF Approved 3-Star Ball from Butterfly
- Very round as the ball has the same thickness at all points
- The bounce more closely resembles that of a celluloid ball
- New material – New feel – New sound – New ball
- Play the best, Play Butterfly
- Made in Germany



EASY BALL 40+

- The new Easy Ball from Butterfly is great for multi-ball practice
- Perfect for training with your new Amicus series robot
- Longer lasting than most plastic balls on the market
- A new production process easily creates a very round ball with an amazingly even bounce
- Very new, very round, very easy
- Made in Germany



MASTER QUALITY 40+

- The new Master Quality ball from Butterfly
- Ideal for multi-ball practice, robot training and match play
- Produced using the same guidelines as the other German-made plastic balls
- Long lasting, high-quality plastic ball
- Made in Germany



TRAINING BALL BUCKET

- 72 Standard Training Balls
- Comes in a Vinyl Bucket with Zipper Top
- Carrying Handle
- Adjustable Shoulder Strap
- Made of Celluloid



KURANEL BALL HOLDER

- Neatly Holds and Protects Your Balls
- Keyring Clip for Convenience



ROLLER BOX

- Can Be Used as a Hard Plastic Box for 6 Balls or as a Rolling Pin for Rubbers





AMICUS BASIC

EXCELLENT FOR HIGH-INTENSITY TRAINING OF STROKE TECHNIQUE AND FOOTWORK

- 6 Balls Per Exercise with Different Position
- Random Function - Balls with a Natural Scattering
- Spin, Speed and Trajectory Adjustable



AMICUS ADVANCE

IDEAL PARTNER FOR THOSE WHO WANT TO TRAIN COMPLEX PLAY SEQUENCES

- For Each Ball An Exercise Individually Adjustable:
Spin + Speed + Trajectory + Placement
- Complete Ball Sequences Include Service
- Up To 10 Saved Exercises
- AFC Function (Automatic Frequency Control):
For Automatic Adjustment Of The Time Intervals
Between Balls With Different Speed And Spin
- Sample Function: To Play Balls Individually And Customize
Their Settings with Different Speed And Spin



AMICUS PROFESSIONAL

FOR THE AMICUS PROFESSIONAL YOU DON'T HAVE TO BE A REAL PROFESSIONAL - JUST REQUIRING THE HIGHEST POSSIBLE STANDARDS IS ENOUGH.

- 8 Balls Per Exercise
- 99 Exercises Saved
- Remote Control (On/Off and Speed Variation)
- IFC (Individual Frequency Control): For Individual Needs
- Cycle Function: For Automatic Game Breaks



AINO T-SHIRT

- Quick Drying
Moisture Wicking Material
- Micro Dry Fit
(100% Polyester)



AINO LADY T-SHIRT

- Quick Drying
Moisture Wicking Material
- Micro Dry Fit
(100% Polyester)



TENERGY T-SHIRT **New** >>>

- Material: Micro Dry Fit
(100% Polyester)



TENERGY LADY T-SHIRT **New** >>>

- Material: Micro Dry Fit
(100 % Polyester)



BAMBOO SHIRT **New** >>>

- Non-Wrinkling, Anti-Static
And Anti-Odorant
- Material:
81% Nano Bamboo Charcoal
Polyester, 6% Nylon,
13% Spandex



COZY SHIRT

- Honey Comb Dry Fit
(100% Polyester)



KIDO SHIRT **New** >>>

- Dry Fit Material Keeps The
Skin Cool And Dry
- Material: Micro Dry Fit
(100% Polyester)



KIDO LADY SHIRT **New** >>>

- Dry Fit Material Keeps The
Skin Cool And Dry
- Material: Micro Dry Fit
(100% Polyester)



CANADA TEAM SHIRT

- Material: Micro Polyester
(100% Polyester)



MIRA LADY SHIRT

- Material: Cool Dry Lycra
(100% Polyester)



NASH SHIRT

- Material: Dry Fit + Mesh
(100% Polyester)



NASH LADY SHIRT

- Material: Dry Fit + Mesh
(100% Polyester)



XERO SHIRT

- Material: Micro Dry Fit
(100% Polyester)



USA TEAM SHIRT **New**

- Material: Moisture Wicking Polyester
(100 % Polyester)



KOKI SHIRT **New**

- Material: Micro Dry Fit
(100% Polyester)



TAORI SHIRT **New**

- Material: Honey Comb Dry Fit
(100% Polyester)



KUMA SHIRT

- Material: Micro Dry Fit
(100% Polyester)



AVIO JACKET **New** >>>

- Material: Bonded Fleece
(100% Polyester)



AVIO LADY JACKET **New** >>>

- Material: Bonded Fleece
(100% Polyester)



KIDO TRACKSUIT **New** >>>

- Material: Jaquard Stripe Mesh
(100% Polyester)



KIDO LADY TRACKSUIT **New** >>>

- Material: Jaquard Stripe Mesh
(100% Polyester)



NINYO TRACKSUIT **New** >>>

- Material: Laminated Fleece
(100% Polyester)



NINYO LADY TRACKSUIT **New** >>>

- Material: Laminated Fleece
(100% Polyester)



COZY TRACKSUIT

- Material: American Terry (80% Cotton, 20% Polyester)



USA TEAM TRACKSUIT **New**

- Material: 97% polyester and 3% Elastic Shell 100% Polyester



KUMA TRACKSUIT

- Material: Dimple Dry Fit (100% Polyester)



TAORI TRACKSUIT **New**

- Material: Performance Micro (100% Polyester)



MIRA LADY TRACKSUIT

- Material: Jacquard Stripe Mesh (100% Polyester)



NASH TRACKSUIT

- Material: Poly Terry (100% Polyester)



PASSO TRACKSUIT

- Material: 100% Polyester



USA TEAM SHORTS **New**»»

- Material: 97% polyester and 3% Elastic



APEGO SHORTS

- Material: Dimple Dry Fit (100% Polyester)



KIDO SHORTS **New**»»

- Material: Stretch Polyester / Cool Dry Lycra (100% Polyester)



NASH SHORTS

- Material: Dimple Dry Fit (100% Polyester)



PIRUS SHORTS **New**»»

- Material: Plain Micro (100% Polyester)



CHI SHORTS

- Material: 100% Polyester



AQUILA LADY SHORTS **New**»»

- Material: Cool Dry Lycra (100% Polyester)



CHIARA SKIRT **New**»»

- Material: Cool Dry Lycra (92% Polyester, 8% Spandex)



RADIAL CROSS **New**»»

- Dynamic and flexible shoe that provides a firm grip on any surface
- Perfect companion for indoor and outdoor leisure activity
- Sizes: 5.5-10.0



LEZOLINE TB

- Comfortable fit with additional stability and shock dampening
- Breathable flexible material
- Colors: Blue, Sky
- Sizes: Blue: 4.0-12.0
Sky: 4.5-11.5



LEZOLINE ZERO

- Provides the utmost flexibility; a shoe specifically made for table tennis
- Fantastic grip and stability
- Absorbent mesh material keeps the foot dry and comfortable
- Sizes: 5.0-10.5



GEMELLIO SOCKS **New**»»

- Quick drying and antibacterial
- Material: Cotton/Acrylic/Polyester/Polyurethane



LAZER SOCKS **New**»»

- Quick drying and antibacterial
- Material: Cotton/Acrylic/Polyester/Polyurethane



BL SHOE BAG

- Fits one pair of shoes
- Drawstring pull
- Material: PVC
- Colors: Black/Pink, Blue/Silver
Black/Green, Blue/Pink



UTOP **New**»»

- Optimally structured outer sole provides a secure grip and stability
- The lightweight, breathable mesh upper ensures excellent ventilation
- Sizes: 5.0-10.5



LEZOLINE SONIC

- EVA midsole provides good support and cushion
- Mesh upper offers good breathability
- Colors: Blue, Green, Pink, White
- Sizes:
Blue: 4.5-8.5, 10.0
Green: 4.5-7.5, 9.0, 10.0
Pink: 5.5-8.0
White: 4.5-5.5



LEZOLINE LAZER

- The Lezoline Lazer Shoe was designed to be lightweight, yet strong
- Mesh construction provides good breathability; rubber and EVA sole
- Sizes: Red: 4.5, 7.0-11.0
Grey: 4.5, 5.0, 7.0-8.0, 9.0-10.0, 11.0
White: 4.5, 7.0-11.0
Blue: 4.5, 5.5, 7.5, 10.0



INNERSOLES

- Provides extra cushion
- Provides secure feeling
- Sizes: S - XL



BIG LOGO TOWEL

- Size: 70 cm x 140 cm
- Material: 100% Cotton



GERMANY TOWEL

- German flag design
- Size: 50 cm x 100 cm
- 100% cotton



NELOFY TOWEL

- Simple and elegant design
- Part of the Nelofy series
- Made of 100% Cotton
- Size: 35 cm x 115 cm



TENERGY TOWEL

- Black with gray lettering
- Made of 100% cotton
- 100 cm x 50 cm



LOGO TOWEL

- Simple and stylish design with the all new Butterfly logo
- Made of 100% Cotton
- Size: 70 cm x 140 cm



WING TOWEL

- 100% cotton
- 50 cm x 100 cm



MAXI BLADE

- Enlarged wooden blade.
- Ideal for signature collecting.
- Dimensions 16 ½ x 11 ¼ in.



MIDI BLADE

- Midi size wooden blade.
- Exact replica of a regular blade.
- Dimensions 8 ½ x 5 in.



MINI BLADE

- Miniature wooden blade.
- Exact replica of a regular blade.
- Dimensions 6 x 3 ½ in.



KEYHOLDER BUTTERFLY

- Butterfly Logo on Front
- Butterfly Wing Logo on the Reverse Side



TENERGY KEYHOLDER

- Heavy duty keychain
- Tenergy logo on the front side
- "Butterfly Living Table Tennis" on the reverse side
- Tenergy - the 'key' to success.



KEYLACE

- Butterfly logo key lace with detachable keyring



BOTTLE OPENER

- Aluminum bottle opener keychain
- Metal split ring comes attached



NL HEADBAND

- One size fits all
- Cotton, polyester, acrylic, nylon and polyurethane



NL WRISTBAND

- One size fits all
- Cotton, polyester, acrylic, nylon and polyurethane



CAP BUTTERFLY

- Perfect for sports and leisure wear
- Modern neutral color design in grey with white logo
- One size fits all



NOTE BLOCK

- Keep tabs on all your opponents
- Non-adhesive post notes
- Each page has Butterfly wing logo



BTY MARKING PEN

- High quality magic marker
- Medium point
- Quick drying black ink
- Butterfly logo in pink and white



PEN BLACK

- Black pen with white "BUTTERFLY" printed on it, blue ink



BTY BALLPOINT PEN

- Clickable black ink option and a red ink option



BTY WATER BOTTLE

- Clear side for accurate measurements
- Easy grip top with large hinged lid cap



TENERGY WATER BOTTLE

- Clear side for accurate measurements
- Easy grip top with large hinged lid cap



CLASSIC PIN

- Attractive lapel pin
- Butterfly logo is debossed in gold with blue background and gold trim
- Stick pin back with safety clasp closure
- 1 3/8" long x 5/16" tall



PATCHES

- Can be sewn or ironed on
- Classic or Stacked Logo



CHEER STICKS

- Make some noise!
- Cheer on your favorite player with the inflatable Cheer Sticks
- Comes with two sticks and straw to inflate
- 25" long x 4" tall.



STICKY CLEANER

- Microfiber pad for cleaning touch screens, lint and scratch free
- Adhesive reverse side for mounting on device
- Butterfly wing logo design in Magenta or White



SUPER MINI BAT

- The Super Mini Bat is a miniature version of an actual racket measuring 1.4" x 2.2"
- Comes with red and black rubber and a thin layer of sponge
- Includes clasp so it can easily be added to a keychain
- Complete with Butterfly side tape



New >>>

&

COMING SOON



BRYCE HIGHSPEED



FREITAS ALC



BOLL CONTROL



GIONIS CARBON ALLROUND



INNERFORCE LAYER ALC CS



TIMO BOLL ZLF



PRO DX CASE



IMPARTIAL XB



APOLONIA ZLC



BOLL FORTE



GIONIS CARBON OFFENSIVE



INNERFORCE LAYER ALC S CS



TIMO BOLL ZLC



PRO TOUR CASE



IMPARTIAL XS



BOLL OFFENSIVE



INNERFORCE LAYER ALC S



GIONIS CARBON DEFENSIVE



ZHANG JIKE SZLC



TIMO BOLL ALC



PRO FULL CASE



KENTA MATSUDAIRA ALC



BOLL ALLROUND



INNERFORCE LAYER ZLF



INNERFORCE LAYER ZLF CS



PRIMORAC CARBON



STRAVE



LOGO TOUR CASE



TENERGY T-SHIRT



BAMBOO SHIRT



KIDO SHIRT



USA TEAM SHIRT



TENERGY LADY T-SHIRT



KOKI SHIRT



UTOP



AVIO JACKET



KIDO TRACKSUIT



NINYO TRACKSUIT



USA TEAM TRACKSUIT



TAORI TRACKSUIT

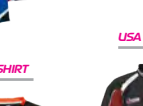

GEMELLO SOCKS



LAZER SOCKS



AVIO LADY JACKET



KIDO LADY TRACKSUIT



NINYO LADY TRACKSUIT



TAORI LADY TRACKSUIT



CHIARA SKIRT

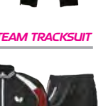

RADIAL COACH



USA TEAM SHORTS



KIDO SHORTS

PIRUS SHORTS

AQUILA LADY SHORTS

LAZER SOCKS



We are Butterfly





BUTTERFLY

